



**KSZTAŁTKI
SEGMENTOWE
WTRYSKOWE DOCZOŁOWE
AKCESORIA**

Katalog produktów

35
lat

www.zinplast.pl

Spis treści

01	Kształtki segmentowe
	Do wody i kanalizacji ciśnieniowej PE100
	str 05

02	Kształtki wtryskowe doczołowe
	Do wody i kanalizacji ciśnieniowej PE100
	str 31

03	Akcesoria
	Adaptory mosiężne
	str 36
	Kołnierze stalowe
	str 37
	Uszczelki gumowe
	str 38



01

.....

Kształtki segmentowe

Do wody i kanalizacji ciśnieniowej
PE100

.....



.....

www.zinplast.pl

Kształtki segmentowe do wody i kanalizacji ciśnieniowej PE100

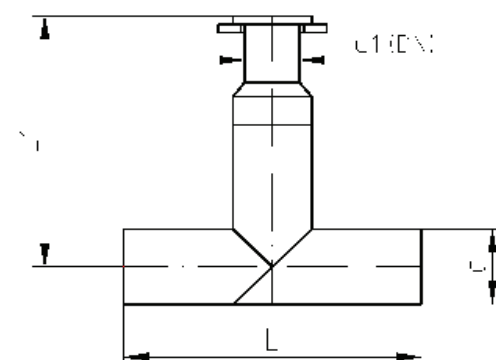
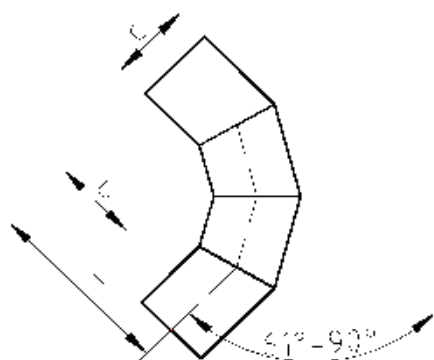
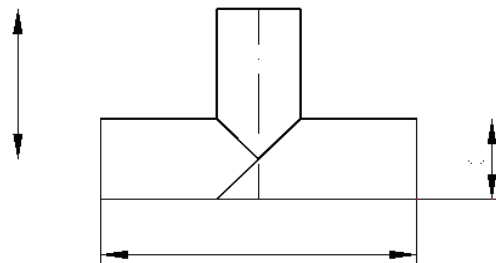
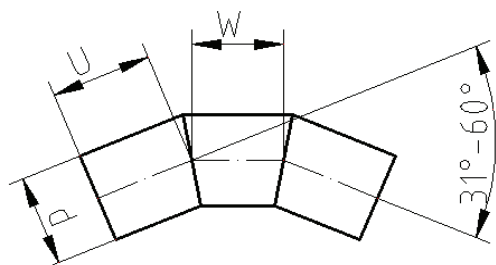

Specyfikacja techniczna

Budowa kształtki:	kształtki segmentowe jednowarstwowe i dwuwarstwowe
Przeznaczenie:	kształtki polietylenowe przeznaczone do wody i kanalizacji ciśnieniowej
Kolor:	czarny, woda - czarny z niebieskimi paskami, kanalizacja - czarny, czarny z brązowymi paskami woda RC - kolor granatowy/czarny, czarny z niebieskimi paskami/czarny kanalizacja RC - kolor czarny/ czarny, brązowy/czarny
Normy produktu:	PN-EN 12201-3+A1
Materiał:	PE 100, PE 100 RC
Wymiary:	Ø90 do Ø 630 ; SDR 41 do SDR 7,4
Klasyfikacja statystyczna wyrobu:	PKWiU 25.21-21-53-10
Forma dostawy:	Pakowane zbiorczo lub osobno w opakowania kartonowe lub foliowe
Dopuszczenia:	Aktualne dokumenty odniesienia znajdują się na stronie www.zinplast.pl

Współczynniki ciśnieniowe

Łuki segmentowe

Zgodnie z normą PN-EN 12201-3 "Systemy przewodów rurowych z tworzyw sztucznych do przesyłania wody oraz do ciśnieniowej kanalizacji deszczowej i sanitarnej. Polietylen (PE) Część 3: Kształtki", kształtki fabrykowane z segmentów rury litej przejmują klasę PN od zastosowanej rury wraz z geometrycznym współczynnikiem obniżającym.

Kąt cięcia β	Współczynnik obniżający f_B
$\leq 7.5^\circ$	1.0
$7.5^\circ < \beta \leq 15^\circ$	0.8

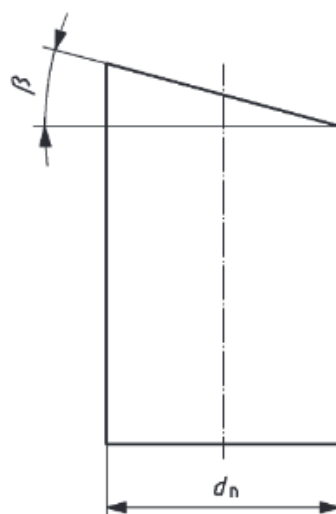

Opis

d_n nominalna średnica zewnętrzna

β kąt cięcia

Aby otrzymać klasę PN kształtki należy wykorzystać poniższe równanie:

$$[PN] = f_B * [PN]_{rury}$$

$[PN]_{rury}$ – nominalne ciśnienie rury

f_B – geometryczny współczynnik obniżający

Stosując kąt cięcia segmentu $\beta \leq 7.5^\circ$ łuk segmentowy zachowuje wytrzymałość ciśnieniową rury wykorzystanej do jego wytworzenia - co zwiększa wymaganą liczbę segmentów do otrzymania oczekiwanego kąta

Trójniki segmentowe

Zgodnie z normą PN-EN 12201-3 "Systemy przewodów rurowych z tworzyw sztucznych do przesyłania wody oraz do ciśnieniowej kanalizacji deszczowej i sanitarnej. Polietylen (PE) Część 3: Kształtki" trójniki fabrykowane z segmentów również podlegają równaniu na klasę PN, z ustalonym współczynnikiem obniżającym o wartości stałej $f_T = 0.6$

$$[PN] = f_T * [PN]_{rury}$$

$[PN]_{rury}$ – nominalne ciśnienie rury

f_T – geometryczny współczynnik obniżający

Łuk segmentowy PE100 1°-30°

d/d1	U [±10]	SDR11		SDR17	
		index	cena	index	cena
90	140	LS1130090	49,00	LS1730090	40,00
110	150	LS1130110	68,00	LS1730110	51,00
125	155	LS1130125	83,00	LS1730125	62,00
140	160	LS1130140	101,00	LS1730140	78,00
160	170	LS1130160	125,00	LS1730160	99,00
180	170	LS1130180	150,00	LS1730180	121,00
200	170	LS1130200	195,00	LS1730200	144,00
225	195	LS1130225	235,00	LS1730225	180,00
250	200	LS1130250	330,00	LS1730250	248,00
280	235	LS1130280	420,00	LS1730280	310,00
315	270	LS1130315	580,00	LS1730315	420,00
355	285	LS1130355	920,00	LS1730355	610,00
400	300	LS1130400	1,120,00	LS1730400	840,00
450	360	LS1130450	1,900,00	LS1730450	1 400,00
500	450	LS1130500	2,650,00	LS1730500	1 800,00
560	500	LS1130560	3,850,00	LS1730560	2 470,00
630	520	LS1130630	4,950,00	LS1730630	3 300,00

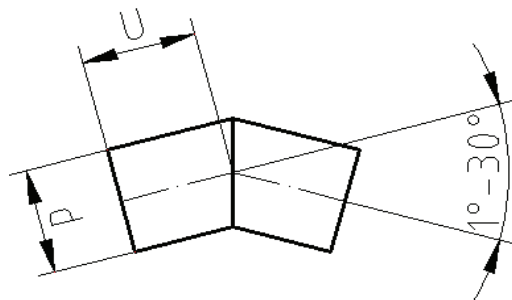

* PE100RC dostępne na zapytanie

Łuk segmentowy PE100 31°-60°

d/d1	U [±10]	W [±10]	SDR11		SDR17	
			index	cena	index	cena
90	140	120	LS1160090	85,00	LS1760090	69,00
110	150	120	LS1160110	106,00	LS1760110	90,00
125	155	140	LS1160125	133,00	LS1760125	112,00
140	160	145	LS1160140	165,00	LS1760140	137,00
160	170	150	LS1160160	205,00	LS1760160	172,00
180	170	155	LS1160180	255,00	LS1760180	213,00
200	170	170	LS1160200	318,00	LS1760200	257,00
225	195	180	LS1160225	400,00	LS1760225	305,00
250	200	185	LS1160250	530,00	LS1760250	390,00
280	235	205	LS1160280	700,00	LS1760280	485,00
315	270	230	LS1160315	890,00	LS1760315	610,00
355	285	265	LS1160355	1,300,00	LS1760355	910,00
400	300	295	LS1160400	1,650,00	LS1760400	1 300,00
450	370	350	LS1160450	3,000,00	LS1760450	2 040,00
500	470	400	LS1160500	4,150,00	LS1760500	2 700,00
560	520	450	LS1160560	5,650,00	LS1760560	3 740,00
630	540	510	LS1160630	7,600,00	LS1760630	4 975,00

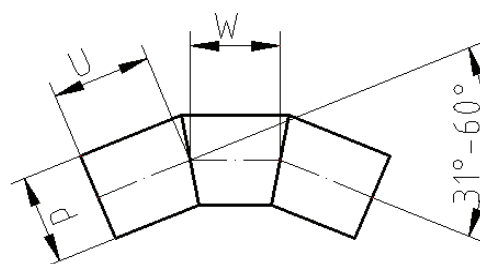

* PE100RC dostępne na zapytanie

Łuk segmentowy PE100 61°-90°

d/d1	U [±10]	W [±10]	SDR11		SDR17	
			index	cena	index	cena
90	140	300	LS1190090	128,00	LS1790090	103,00
110	150	310	LS1190110	150,00	LS1790110	128,00
125	155	340	LS1190125	193,00	LS1790125	164,00
140	160	355	LS1190140	230,00	LS1790140	189,00
160	170	370	LS1190160	280,00	LS1790160	237,00
180	170	380	LS1190180	355,00	LS1790180	304,00
200	170	400	LS1190200	445,00	LS1790200	362,00
225	195	440	LS1190225	560,00	LS1790225	440,00
250	200	450	LS1190250	730,00	LS1790250	552,00
280	235	515	LS1190280	920,00	LS1790280	690,00
315	270	580	LS1190315	1,220,00	LS1790315	840,00
355	285	645	LS1190355	1,720,00	LS1790355	1 250,00
400	300	700	LS1190400	2,250,00	LS1790400	1 700,00
450	360	800	LS1190450	4,080,00	LS1790450	2 450,00
500	450	950	LS1190500	5,600,00	LS1790500	3 380,00
560	500	1060	LS1190560	7,650,00	LS1790560	4 550,00
630	520	1170	LS1190630	10,050,00	LS1790630	6 200,00

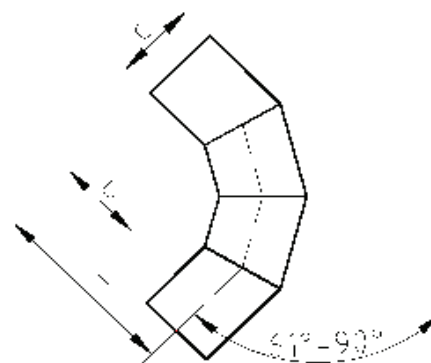

* PE100RC dostępne na zapytanie

Łuk segmentowy pełnościenny 1°-15°

d	U	W	H	SDR11		SDR17	
				index	cena	index	cena
90	145	130	285	LP1115090	49,00	LP1715090	40,00
110	150	135	300	LP1115110	68,00	LP1715110	50,00
125	160	150	320	LP1115125	83,00	LP1715125	62,00
140	170	160	335	LP1115140	101,00	LP1715140	75,00
160	180	170	390	LP1115160	125,00	LP1715160	95,00
180	180	175	360	LP1115180	150,00	LP1715180	115,00
200	180	175	350	LP1115200	195,00	LP1715200	130,00
225	210	210	415	LP1115225	235,00	LP1715225	170,00
150	220	215	430	LP1115250	330,00	LP1715250	235,00
280	250	245	495	LP1115280	420,00	LP1715280	290,00
315	290	270	570	LP1115315	580,00	LP1715315	358,00
355	305	315	600	LP1115355	920,00	LP1715355	575,00
400	325	350	635	LP1115400	1,120,00	LP1715400	710,00
450	390	380	765	LP1115450	1,900,00	LP1715450	1 250,00
500	490	435	960	LP1115500	2,650,00	LP1715500	1 800,00
560	545	485	1070	LP1115560	3,850,00	LP1715560	2 480,00
630	570	560	1120	LP1115630	4,950,00	LP1715630	3 400,00

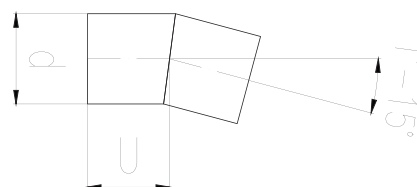

Tolerancja wymiaru H dla DN90 – 315 ±1 cm
 Tolerancja wymiaru H dla DN355 – 630 ±2 cm
 Możliwość wydłużenia segmentów granicznych na życzenie klienta

Łuk segmentowy pełnościeniowy 16°-30°

d	U	W	H	SDR11		SDR17	
				index	cena	index	cena
90	145	130	390	LP1130090	95,00	LP1730090	82,00
110	150	135	415	LP1130110	120,00	LP1730110	80,00
125	160	150	450	LP1130125	155,00	LP1730125	124,00
140	170	160	475	LP1130140	190,00	LP1730140	145,00
160	180	170	535	LP1130160	235,00	LP1730160	170,00
180	180	175	512	LP1130180	285,00	LP1730180	205,00
200	180	175	500	LP1130200	350,00	LP1730200	260,00
225	210	210	595	LP1130225	460,00	LP1730225	325,00
150	220	215	615	LP1130250	600,00	LP1730250	430,00
280	250	245	705	LP1130280	820,00	LP1730280	520,00
315	290	270	800	LP1130315	1 055,00	LP1730315	710,00
355	305	315	875	LP1130355	1 560,00	LP1730355	950,00
400	325	350	940	LP1130400	2 000,00	LP1730400	1 250,00
450	390	380	1100	LP1130450	3 000,00	LP1730450	2 000,00
500	490	435	1330	LP1130500	4 000,00	LP1730500	2 860,00
560	545	485	1485	LP1130560	5 500,00	LP1730560	3 800,00
630	570	560	1600	LP1130630	7 250,00	LP1730630	5 000,00

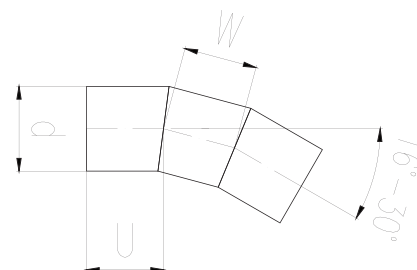

Tolerancja wymiaru H dla DN90 – 315 ±1 cm
 Tolerancja wymiaru H dla DN355 – 630 ±2 cm
 Możliwość wydłużenia segmentów granicznych na życzenie klienta

Łuk segmentowy pełnościeniowy 31°-45°

d	U	W	H	SDR11		SDR17	
				index	cena	index	cena
90	145	130	480	LP1145090	130,00	LP1745090	115,00
110	150	135	510	LP1145110	170,00	LP1745110	135,00
125	160	150	560	LP1145125	220,00	LP1745125	174,00
140	170	160	585	LP1145140	260,00	LP1745140	210,00
160	180	170	650	LP1145160	340,00	LP1745160	250,00
180	180	175	635	LP1145180	395,00	LP1745180	300,00
200	180	175	630	LP1145200	500,00	LP1745200	385,00
225	210	210	745	LP1145225	650,00	LP1745225	475,00
150	220	215	770	LP1145250	850,00	LP1745250	600,00
280	250	245	975	LP1145280	1 100,00	LP1745280	735,00
315	290	270	985	LP1145315	1 450,00	LP1745315	950,00
355	305	315	1100	LP1145355	2 050,00	LP1745355	1 350,00
400	325	350	1190	LP1145400	2 700,00	LP1745400	1 730,00
450	390	380	1360	LP1145450	4 100,00	LP1745450	2 850,00
500	490	435	1625	LP1145500	5 400,00	LP1745500	3 940,00
560	545	485	1820	LP1145560	7 350,00	LP1745560	5 200,00
630	570	560	1990	LP1145630	9 700,00	LP1745630	6 700,00

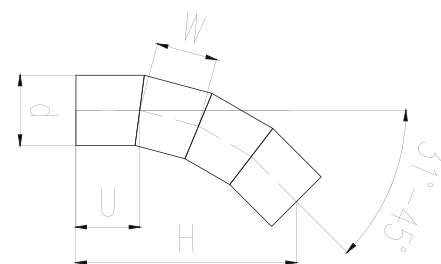

Tolerancja wymiaru H dla DN90 – 315 ±1 cm
 Tolerancja wymiaru H dla DN355 – 630 ±2 cm
 Możliwość wydłużenia segmentów granicznych na życzenie klienta

Łuk segmentowy pełnościeniowy 46°-60°

d	U	W	H	SDR11		SDR17	
				index	cena	index	cena
90	145	130	540	LP1160090	175,00	LP1760090	146,00
110	150	135	575	LP1160110	230,00	LP1760110	190,00
125	160	150	630	LP1160125	290,00	LP1760125	235,00
140	170	160	665	LP1160140	355,00	LP1760140	275,00
160	180	170	730	LP1160160	430,00	LP1760160	335,00
180	180	175	725	LP1160180	520,00	LP1760180	400,00
200	180	175	710	LP1160200	680,00	LP1760200	520,00
225	210	210	850	LP1160225	840,00	LP1760225	615,00
150	220	215	880	LP1160250	1 050,00	LP1760250	780,00
280	250	245	995	LP1160280	1 450,00	LP1760280	955,00
315	290	270	1115	LP1160315	2 300,00	LP1760315	1 500,00
355	305	315	1255	LP1160355	3 100,00	LP1760355	1 980,00
400	325	350	1365	LP1160400	3 500,00	LP1760400	2 280,00
450	390	380	1550	LP1160450	5 100,00	LP1760450	3 770,00
500	490	435	1835	LP1160500	6 950,00	LP1760500	5 080,00
560	545	485	2050	LP1160560	9 200,00	LP1760560	6 600,00
630	570	560	2270	LP1160630	11 950,00	LP1760630	8 400,00

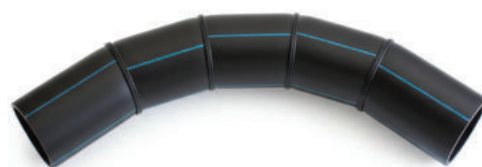
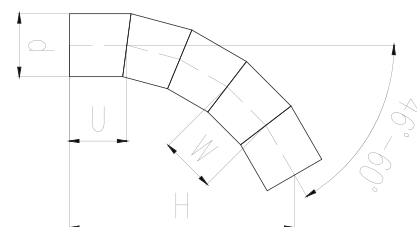

Tolerancja wymiaru H dla DN90 – 315 ±1 cm
 Tolerancja wymiaru H dla DN355 – 630 ±2 cm
 Możliwość wydłużenia segmentów granicznych na życzenie klienta

Łuk segmentowy pełnościeniowy 61°-75°

d	U	W	H	SDR11		SDR17	
				index	cena	index	cena
90	145	130	570	LP1175090	200,00	LP1775090	185,00
110	150	135	605	LP1175110	280,00	LP1775110	240,00
125	160	150	670	LP1175125	355,00	LP1775125	290,00
140	170	160	705	LP1175140	425,00	LP1775140	345,00
160	180	170	740	LP1175160	530,00	LP1775160	410,00
180	180	175	765	LP1175180	650,00	LP1775180	500,00
200	180	175	755	LP1175200	795,00	LP1775200	640,00
225	210	210	905	LP1175225	1 000,00	LP1775225	755,00
150	220	215	935	LP1175250	1 300,00	LP1775250	940,00
280	250	245	1055	LP1175280	1 780,00	LP1775280	1 150,00
315	290	270	1180	LP1175315	2 700,00	LP1775315	1 750,00
355	305	315	1340	LP1175355	3 600,00	LP1775355	2 390,00
400	325	350	1465	LP1175400	4 200,00	LP1775400	2 810,00
450	390	380	1650	LP1175450	6 200,00	LP1775450	4 620,00
500	490	435	1930	LP1175500	8 400,00	LP1775500	6 150,00
560	545	485	2160	LP1175560	11 100,00	LP1775560	8 010,00
630	570	560	2410	LP1175630	14 650,00	LP1775630	10 350,00

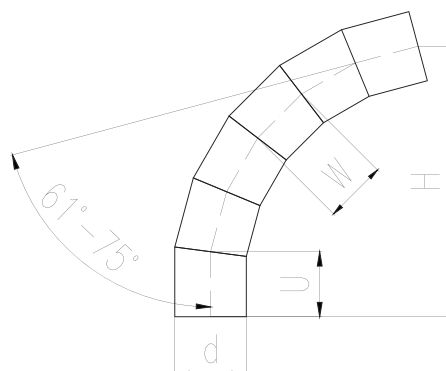

Tolerancja wymiaru H dla DN90 – 315 ±1 cm
 Tolerancja wymiaru H dla DN355 – 630 ±2 cm
 Możliwość wydłużenia segmentów granicznych na życzenie klienta

Łuk segmentowy pełnościeniowy 76°-90°

d	U	W	H	SDR11		SDR17	
				index	cena	index	cena
90	145	130	565	LP1190090	230,00	LP1790090	215,00
110	150	135	600	LP1190110	330,00	LP1790110	275,00
125	160	150	665	LP1190125	415,00	LP1790125	355,00
140	170	160	700	LP1190140	500,00	LP1790140	420,00
160	180	170	735	LP1190160	615,00	LP1790160	500,00
180	180	175	760	LP1190180	760,00	LP1790180	600,00
200	180	175	755	LP1190200	960,00	LP1790200	750,00
225	210	210	900	LP1190225	1 220,00	LP1790225	900,00
150	220	215	930	LP1190250	1 550,00	LP1790250	1 120,00
280	250	245	1050	LP1190280	2 100,00	LP1790280	1 350,00
315	290	270	1175	LP1190315	2 800,00	LP1790315	1 820,00
355	305	315	1340	LP1190355	3 800,00	LP1790355	2 550,00
400	325	350	1470	LP1190400	4 900,00	LP1790400	3 340,00
450	390	380	1645	LP1190450	7 300,00	LP1790450	5 460,00
500	490	435	1920	LP1190500	9 800,00	LP1790500	7 200,00
560	545	485	2150	LP1190560	13 000,00	LP1790560	9 400,00
630	570	560	2405	LP1190630	17 050,00	LP1790630	12 150,00

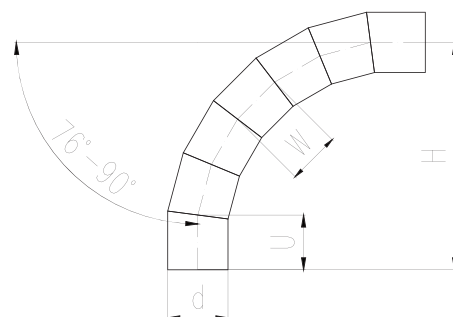

Tolerancja wymiaru H dla DN90 – 315 ±1 cm

Tolerancja wymiaru H dla DN355 – 630 ±2 cm

Możliwość wydłużenia segmentów granicznych na życzenie klienta

Trójnik segmentowy PE100 90°

d/d1	U [±10]	SDR11		SDR17	
		index	cena	index	cena
90	140	TS1190090	100,00	TS1790090	87,00
110	150	TS1190110	133,00	TS1790110	116,00
125	155	TS1190125	162,00	TS1790125	133,00
140	160	TS1190140	210,00	TS1790140	168,00
160	170	TS1190160	250,00	TS1790160	207,00
180	170	TS1190180	345,00	TS1790180	274,00
200	170	TS1190200	415,00	TS1790200	338,00
225	195	TS1190225	530,00	TS1790225	390,00
250	200	TS1190250	720,00	TS1790250	530,00
280	235	TS1190280	880,00	TS1790280	670,00
315	270	TS1190315	1 240,00	TS1790315	950,00
355	285	TS1190355	2 100,00	TS1790355	1 450,00
400	300	TS1190400	2 780,00	TS1790400	1 850,00
450	360	TS1190450	5 300,00	TS1790450	3 120,00
500	450	TS1190500	8 860,00	TS1790500	4 400,00
560	500	TS1190560	12 300,00	TS1790560	5 900,00
630	520	TS1190630	16 050,00	TS1790630	8 100,00

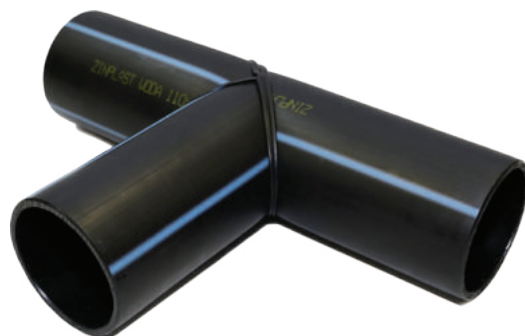
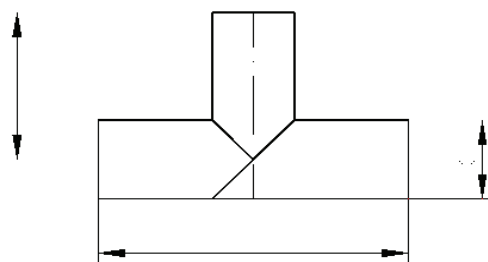

* PE100RC dostępne na zapytanie

Trójnik segmentowy PE100 60°

d	U	W	H	SDR11		SDR17	
				index	cena	index	cena
90	610	200	200	TS1160090	162,00	TS1760090	143,00
110	650	220	220	TS1160110	196,00	TS1760110	177,00
125	700	240	240	TS1145125	255,00	TS1745125	210,00
140	760	300	300	TS1160140	310,00	TS1760140	255,00
160	790	310	310	TS1145160	390,00	TS1745160	310,00
180	810	320	320	TS1160180	540,00	TS1760180	415,00
200	840	330	330	TS1160200	640,00	TS1760200	515,00
225	890	350	350	TS1160225	790,00	TS1760225	600,00
250	950	380	380	TS1160250	1 060,00	TS1760250	740,00

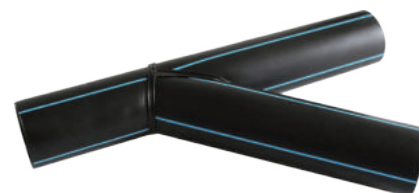
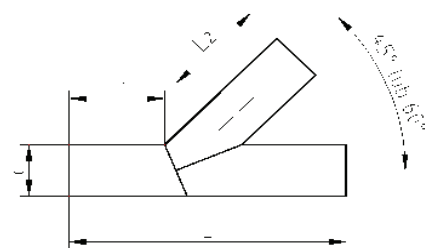

* PE100RC dostępne na zapytanie

Trójnik segmentowy PE100 45°

d	U	W	H	SDR11		SDR17	
				index	cena	index	cena
90	640	200	310	TS1145090	162,00	TS1745090	143,00
110	660	220	310	TS1145110	196,00	TS1745110	177,00
125	700	240	310	TS1145125	255,00	TS1745125	210,00
140	780	300	300	TS1145140	310,00	TS1745140	255,00
160	810	310	320	TS1145160	390,00	TS1745160	310,00
180	850	320	430	TS1145180	540,00	TS1745180	415,00
200	870	330	420	TS1145200	640,00	TS1745200	515,00

* PE100RC dostępne na zapytanie

Trójnik segmentowy redukcyjny PE100 90°

d/d1	L [±10]	L1 [±10]	SDR11		SDR17	
			index	cena	index	cena
90/63	430	325	TY1100001	181,00	TY1700001	175,00
90/75	430	325	TY1100002	181,00	TY1700002	175,00
110/63	430	335	TY1100003	222,00	TY1700003	206,00
110/75	430	335	TY1100004	222,00	TY1700004	206,00
110/90	430	330	TY1100005	222,00	TY1700005	206,00
125/63	490	350	TY1100006	270,00	TY1700006	237,00
125/75	490	350	TY1100007	270,00	TY1700007	237,00
125/90	490	350	TY1100008	270,00	TY1700008	237,00
125/110	490	350	TY1100009	270,00	TY1700009	237,00
140/63	500	360	TY1100010	360,00	TY1700010	330,00
140/90	500	360	TY1100011	360,00	TY1700011	330,00
140/110	500	360	TY1100012	360,00	TY1700012	330,00
140/125	500	360	TY1100013	360,00	TY1700013	330,00
160/63	560	390	TY1100014	415,00	TY1700014	405,00
160/75	560	390	TY1100015	415,00	TY1700015	405,00
160/90	560	400	TY1100016	415,00	TY1700016	405,00
160/110	560	400	TY1100017	415,00	TY1700017	380,00
160/125	560	400	TY1100018	415,00	TY1700018	380,00
160/140	560	400	TY1100019	415,00	TY1700019	380,00
180/63	600	510	TY1100020	710,00	TY1700020	625,00
180/75	600	510	TY1100021	710,00	TY1700021	625,00
180/90	600	520	TY1100022	600,00	TY1700022	525,00
180/110	600	520	TY1100023	600,00	TY1700023	525,00
180/125	600	520	TY1100024	600,00	TY1700024	525,00
180/140	600	520	TY1100025	600,00	TY1700025	525,00
180/160	600	410	TY1100026	600,00	TY1700026	515,00
200/63	620	550	TY1100027	920,00	TY1700027	800,00
200/75	620	550	TY1100028	920,00	TY1700028	800,00
200/90	620	560	TY1100029	820,00	TY1700029	800,00
200/110	620	560	TY1100030	820,00	TY1700030	755,00
200/125	620	560	TY1100031	820,00	TY1700031	755,00
200/140	620	560	TY1100032	820,00	TY1700032	755,00
200/160	620	440	TY1100033	770,00	TY1700033	670,00
200/180	620	400	TY1100034	770,00	TY1700034	670,00
225/63	680	585	TY1100035	1 060,00	TY1700035	960,00
225/75	680	585	TY1100036	1 060,00	TY1700036	960,00
225/90	680	585	TY1100037	1 040,00	TY1700037	960,00
225/110	680	585	TY1100038	1 040,00	TY1700038	920,00
225/125	680	585	TY1100039	1 040,00	TY1700039	920,00
225/140	680	585	TY1100040	1 040,00	TY1700040	920,00
225/160	680	470	TY1100041	950,00	TY1700041	830,00
225/180	680	430	TY1100042	950,00	TY1700042	830,00
225/200	680	430	TY1100043	870,00	TY1700043	830,00
250/63	820	650	TY1100044	1 300,00	TY1700044	1 330,00
250/75	820	650	TY1100045	1 300,00	TY1700045	1 330,00

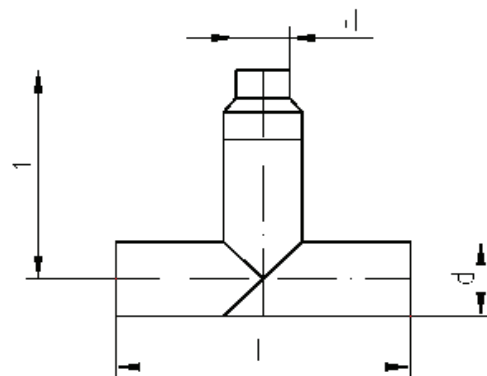

* PE100RC dostępne na zapytanie

Trójnik segmentowy redukcyjny PE100 90°

d/d1	L [±10]	L1 [±10]	SDR11		SDR17	
			index	cena	index	cena
250/90	820	660	TY1100046	1 260,00	TY1700046	1 330,00
250/110	820	660	TY1100047	1 260,00	TY1700047	1 220,00
250/125	820	660	TY1100048	1 280,00	TY1700048	1 220,00
250/140	820	660	TY1100049	1 280,00	TY1700049	1 220,00
250/160	820	540	TY1100050	1 170,00	TY1700050	1 100,00
250/180	820	600	TY1100051	1 170,00	TY1700051	1 100,00
250/200	820	505	TY1100052	1 170,00	TY1700052	1 110,00
250/225	820	505	TY1100053	1 170,00	TY1700053	1 110,00
280/63	860	770	TY1100054	1 810,00	TY1700054	1 700,00
280/75	860	770	TY1100055	1 800,00	TY1700055	1 700,00
280/90	860	780	TY1100056	1 800,00	TY1700056	1 670,00
280/110	860	780	TY1100057	1 780,00	TY1700057	1 620,00
280/125	860	780	TY1100058	1 780,00	TY1700058	1 620,00
280/140	860	780	TY1100059	1 780,00	TY1700059	1 620,00
280/160	860	660	TY1100060	1 560,00	TY1700060	1 560,00
280/180	860	620	TY1100061	1 560,00	TY1700061	1 580,00
280/200	860	620	TY1100062	1 560,00	TY1700062	1 580,00
280/225	860	525	TY1100063	1 465,00	TY1700063	1 450,00
280/250	860	500	TY1100064	1 465,00	TY1700064	1 300,00
315/63	1000	890	TY1100065	2 200,00	TY1700065	2 100,00
315/75	1000	890	TY1100066	2 200,00	TY1700066	2 100,00
315/90	1000	900	TY1100067	2 200,00	TY1700067	2 100,00
315/110	1000	900	TY1100068	2 170,00	TY1700068	2 050,00
315/125	1000	900	TY1100069	2 170,00	TY1700069	2 050,00
315/140	1000	900	TY1100070	2 170,00	TY1700070	2 050,00
315/160	1000	770	TY1100071	2 080,00	TY1700071	1 850,00
315/180	1000	740	TY1100072	2 080,00	TY1700072	1 850,00
315/200	1000	740	TY1100073	2 080,00	TY1700073	1 820,00
315/225	1000	650	TY1100074	2 080,00	TY1700074	1 830,00
315/250	1000	600	TY1100075	2 060,00	TY1700075	1 680,00
315/280	1000	550	TY1100076	2 060,00	TY1700076	1 680,00
355/63	430	325	TY1100077	4 120,00	TY1700077	3 900,00
355/75	430	325	TY1100078	4 120,00	TY1700078	3 900,00
355/90	430	335	TY1100079	4 120,00	TY1700079	3 900,00
355/110	430	335	TY1100080	4 150,00	TY1700080	3 600,00
355/125	430	330	TY1100081	4 150,00	TY1700081	3 600,00
355/140	430	330	TY1100082	4 150,00	TY1700082	3 600,00
355/160	490	350	TY1100083	3 960,00	TY1700083	3 550,00
355/180	490	350	TY1100084	3 960,00	TY1700084	3 550,00
355/200	490	350	TY1100085	3 790,00	TY1700085	3 050,00
355/225	500	360	TY1100086	3 790,00	TY1700086	3 050,00
355/250	500	360	TY1100087	3 790,00	TY1700087	2 850,00
355/280	500	360	TY1100088	3 790,00	TY1700088	2 850,00
355/315	560	390	TY1100089	3 140,00	TY1700089	2 350,00
400/63	560	400	TY1100090	5 900,00	TY1700090	5 000,00

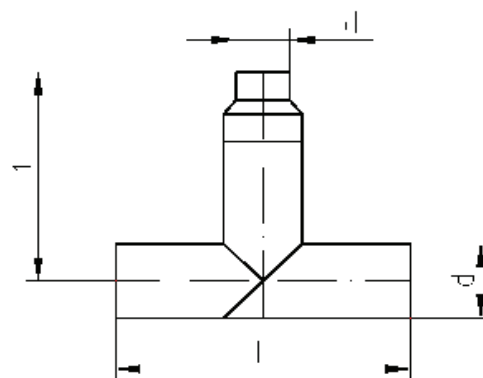

* PE100RC dostępne na zapytanie

Trójnik segmentowy redukcyjny PE100 90°

d/d1	L [±10]	L1 [±10]	SDR11		SDR17	
			index	cena	index	cena
400/75	560	400	TY1100091	5 900,00	TY1700091	5 000,00
400/90	560	400	TY1100092	5 900,00	TY1700092	5 000,00
400/110	560	400	TY1100093	5 900,00	TY1700093	5 150,00
400/125	600	510	TY1100094	5 900,00	TY1700094	5 150,00
400/140	600	510	TY1100095	5 900,00	TY1700095	5 150,00
400/160	600	520	TY1100096	5 750,00	TY1700096	5 000,00
400/180	600	520	TY1100097	5 750,00	TY1700097	5 000,00
400/200	600	520	TY1100098	5 260,00	TY1700098	4 550,00
400/225	600	410	TY1100099	5 450,00	TY1700099	4 550,00
400/250	620	550	TY1100100	4 800,00	TY1700100	4 300,00
400/280	620	560	TY1100101	4 800,00	TY1700101	4 300,00
400/315	620	560	TY1100102	4 440,00	TY1700102	3 800,00
400/355	620	440	TY1100103	4 440,00	TY1700103	3 650,00
450/63	620	400	TY1100104	8 821,73	TY1700104	7 536,54
450/75	620	400	TY1100105	8 821,73	TY1700105	7 536,54
450/90	680	585	TY1100106	8 816,97	TY1700106	7 504,94
450/110	680	585	TY1100107	8 816,97	TY1700107	7 504,94
450/125	680	585	TY1100108	8 816,97	TY1700108	7 504,94
450/140	680	585	TY1100109	8 816,97	TY1700109	7 504,94
450/160	680	585	TY1100110	8 653,49	TY1700110	7 336,55
450/180	680	470	TY1100111	8 562,30	TY1700111	7 230,07
450/200	680	470	TY1100112	8 562,30	TY1700112	7 230,07
450/225	680	430	TY1100113	8 177,91	TY1700113	6 770,94
450/250	820	650	TY1100114	8 177,91	TY1700114	6 770,94
450/280	820	660	TY1100115	8 177,91	TY1700115	6 770,94
450/315	820	660	TY1100116	7 533,94	TY1700116	6 005,34
450/355	820	540	TY1100117	7 423,56	TY1700117	6 462,45
450/400	820	600	TY1100118	7 346,65	TY1700118	6 370,97
500/63	820	505	TY1100119	16 543,10	TY1700119	13 387,63
500/75	820	505	TY1100120	16 543,10	TY1700120	13 387,63
500/90	860	770	TY1100121	16 538,34	TY1700121	13 381,86
500/110	860	770	TY1100122	16 538,34	TY1700122	13 381,86
500/125	860	780	TY1100123	16 538,34	TY1700123	13 381,86
500/140	860	780	TY1100124	16 538,34	TY1700124	13 381,86
500/160	860	780	TY1100125	16 374,86	TY1700125	13 187,65
500/180	860	660	TY1100126	16 283,67	TY1700126	13 079,00
500/200	860	660	TY1100127	15 937,66	TY1700127	13 079,00
500/225	860	620	TY1100128	15 937,66	TY1700128	12 667,63
500/250	860	525	TY1100129	15 937,66	TY1700129	12 667,63
500/280	860	500	TY1100130	15 937,66	TY1700130	12 667,63
500/315	1000	890	TY1100131	15 255,46	TY1700131	11 856,28
500/355	1000	900	TY1100132	15 144,94	TY1700132	11 724,84
500/400	1000	900	TY1100133	15 068,03	TY1700133	11 633,50
500/450	1000	770	TY1100134	13 025,90	TY1700134	9 205,11
560/63	1000	740	TY1100135	19 498,01	TY1700135	15 610,27

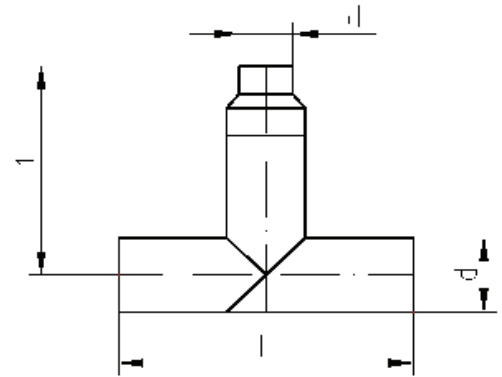

* PE100RC dostępne na zapytanie

Trójnik segmentowy redukcyjny PE100 90°

d/d1	L [±10]	L1 [±10]	SDR11		SDR17	
			index	cena	index	cena
560/75	1000	740	TY1100136	19 498,01	TY1700136	15 610,27
560/90	1000	650	TY1100137	19 493,25	TY1700137	15 604,64
560/110	1000	650	TY1100138	19 493,25	TY1700138	15 604,64
560/125	1000	600	TY1100139	19 493,25	TY1700139	15 604,64
560/140	1000	600	TY1100140	19 493,25	TY1700140	15 604,64
560/160	1000	550	TY1100141	19 329,91	TY1700141	15 410,28
560/180	1660	1370	TY1100142	19 238,58	TY1700142	15 301,78
560/200	1660	1370	TY1100143	19 238,58	TY1700143	15 301,78
560/225	1660	1280	TY1100144	18 892,72	TY1700144	14 890,41
560/250	1660	1230	TY1100145	18 892,72	TY1700145	14 890,41
560/280	1660	1180	TY1100146	18 892,72	TY1700146	14 890,41
560/315	1660	1120	TY1100147	18 892,72	TY1700147	14 238,94
560/355	1660	1070	TY1100148	18 099,84	TY1700148	13 947,62
560/400	1660	1010	TY1100149	18 022,94	TY1700149	13 856,14
560/450	1660	940	TY1100150	15 980,95	TY1700150	11 427,74
560/500	1660	885	TY1100151	16 326,81	TY1700151	12 056,27
630/63	1730	1600	TY1100152	24 802,68	TY1700152	19 067,16
630/75	1730	1600	TY1100153	24 802,68	TY1700153	19 067,16
630/90	1730	1610	TY1100154	24 797,77	TY1700154	19 061,54
630/110	1730	1610	TY1100155	24 797,77	TY1700155	19 061,54
630/125	1730	1610	TY1100156	24 797,77	TY1700156	19 061,54
630/140	1730	1610	TY1100157	24 797,77	TY1700157	19 061,54
630/160	1730	1490	TY1100158	24 631,98	TY1700158	18 867,18
630/180	1730	1450	TY1100159	24 543,10	TY1700159	18 758,67
630/200	1730	1450	TY1100160	24 197,24	TY1700160	18 758,67
630/225	1730	1360	TY1100161	24 197,24	TY1700161	18 347,30
630/250	1730	1310	TY1100162	24 197,24	TY1700162	18 347,30
630/280	1730	1260	TY1100163	24 197,24	TY1700163	18 347,30
630/315	1730	1200	TY1100164	23 514,89	TY1700164	17 535,82
630/355	1730	1150	TY1100165	23 404,37	TY1700165	14 807,30
630/400	1730	1090	TY1100166	23 327,60	TY1700166	17 313,03
630/450	1730	1020	TY1100167	21 285,47	TY1700167	14 884,64
630/500	1730	970	TY1100168	21 011,61	TY1700168	15 524,56
630/560	1730	920	TY1100169	20 848,27	TY1700169	15 330,35

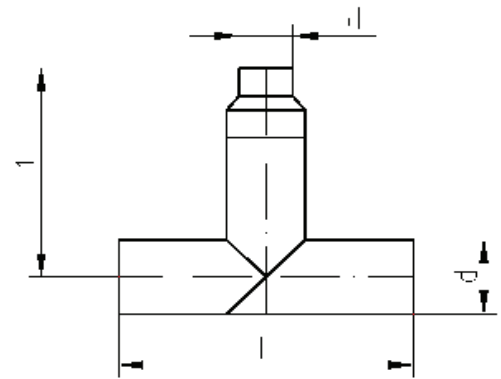

* PE100RC dostępne na zapytanie

Trójkąt segmentowy redukcyjny PE100 60°

d/d1	L [±10]	L1 [±10]	L2 [±10]	L3 [±10]	SDR11		SDR17	
					index	cena	index	cena
90/63	610	200	310	230	TY1100170	210,00	TY1700170	185,00
90/75	610	200	310	230	TY1100171	210,00	TY1700171	185,00
110/63	650	220	310	230	TY1100172	295,00	TY1700172	280,00
110/75	650	220	310	230	TY1100173	295,00	TY1700173	280,00
110/90	650	220	320	230	TY1100174	295,00	TY1700174	280,00
125/63	700	240	310	230	TY1100175	360,00	TY1700175	315,00
125/75	700	240	310	230	TY1100176	360,00	TY1700176	315,00
125/90	700	240	310	230	TY1100177	360,00	TY1700177	315,00
125/110	700	240	310	230	TY1100178	360,00	TY1700178	315,00
140/63	760	300	300	230	TY1100179	530,00	TY1700179	505,00
140/90	760	300	300	230	TY1100180	530,00	TY1700180	505,00
140/110	760	300	300	230	TY1100181	530,00	TY1700181	505,00
140/125	760	300	300	230	TY1100182	530,00	TY1700182	505,00
160/63	790	310	320	230	TY1100183	565,00	TY1700183	480,00
160/75	790	310	320	230	TY1100184	565,00	TY1700184	480,00
160/90	790	310	320	230	TY1100185	565,00	TY1700185	480,00
160/110	790	310	330	230	TY1100186	565,00	TY1700186	480,00
160/125	790	310	320	230	TY1100187	565,00	TY1700187	480,00
160/140	790	310	320	230	TY1100188	565,00	TY1700188	480,00
180/63	810	320	430	230	TY1100189	805,00	TY1700189	730,00
180/75	810	320	430	230	TY1100190	805,00	TY1700190	730,00
180/90	810	320	440	230	TY1100191	805,00	TY1700191	730,00
180/110	810	320	440	230	TY1100192	805,00	TY1700192	730,00
180/125	810	320	430	230	TY1100193	805,00	TY1700193	730,00
180/140	810	320	430	230	TY1100194	805,00	TY1700194	730,00
180/160	810	320	320	230	TY1100195	805,00	TY1700195	645,00
200/63	840	330	420	230	TY1100196	1 190,00	TY1700196	1 060,00
200/75	840	330	420	230	TY1100197	1 190,00	TY1700197	1 060,00
200/90	840	330	430	230	TY1100198	1 190,00	TY1700198	1 035,00
200/110	840	330	430	230	TY1100199	1 175,00	TY1700199	1 035,00
200/125	840	330	420	230	TY1100200	1 175,00	TY1700200	1 060,00
200/140	840	330	420	230	TY1100201	1 175,00	TY1700201	1 060,00
200/160	840	330	350	230	TY1100202	1 105,00	TY1700202	895,00
200/180	840	330	300	230	TY1100203	1 105,00	TY1700203	865,00
225/63	890	350	450	230	TY1100204	1 495,00	TY1700204	1 160,00
225/75	890	350	450	230	TY1100205	1 495,00	TY1700205	1 160,00
225/90	890	350	470	230	TY1100206	1 495,00	TY1700206	1 140,00
225/110	890	350	470	230	TY1100207	1 495,00	TY1700207	1 140,00
225/125	890	350	450	230	TY1100208	1 495,00	TY1700208	1 140,00
225/140	890	350	450	230	TY1100209	1 495,00	TY1700209	1 140,00
225/160	890	350	350	230	TY1100210	1 400,00	TY1700210	1 050,00
225/180	890	350	320	230	TY1100211	1 400,00	TY1700211	1 000,00
225/200	890	350	320	230	TY1100212	1 475,00	TY1700212	1 000,00
250/63	950	380	460	230	TY1100213	1 700,00	TY1700213	1 400,00
250/75	950	380	460	230	TY1100214	1 700,00	TY1700214	1 400,00

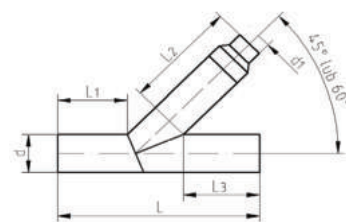

* PE100RC dostępne na zapytanie

Trójnik segmentowy redukcyjny PE100 60°

d/d1	L [±10]	L1[±10]	L2[±10]	L3[±10]	SDR11		SDR17	
					index	cena	index	cena
250/90	950	380	480	230	TY1100215	1 700,00	TY1700215	1 380,00
250/110	950	380	480	230	TY1100216	1 700,00	TY1700216	1 380,00
250/125	950	380	460	230	TY1100217	1 700,00	TY1700217	1 410,00
250/140	950	380	460	230	TY1100218	1 700,00	TY1700218	1 410,00
250/160	950	380	350	230	TY1100219	1 530,00	TY1700219	1 260,00
250/180	950	380	420	230	TY1100220	1 530,00	TY1700220	1 365,00
250/200	950	380	320	230	TY1100221	1 520,00	TY1700221	1 200,00
250/225	950	380	320	230	TY1100222	1 375,00	TY1700222	1 200,00

* PE100RC dostępne na zapytanie

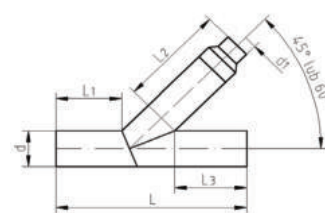

Trójnik segmentowy redukcyjny PE100 45°

d/d1	L [±10]	L1[±10]	L2[±10]	L3[±10]	SDR11		SDR17	
					index	cena	index	cena
90/63	640	200	310	230	TY1100223	210,00	TY1700223	185,00
90/75	640	200	310	230	TY1100224	210,00	TY1700224	185,00
110/63	660	220	310	230	TY1100225	310,00	TY1700225	280,00
110/75	660	220	310	230	TY1100226	300,00	TY1700226	280,00
110/90	700	220	320	230	TY1100227	300,00	TY1700227	280,00
125/63	700	240	310	230	TY1100228	360,00	TY1700228	315,00
125/75	700	240	310	230	TY1100229	360,00	TY1700229	315,00
125/90	700	240	310	230	TY1100230	360,00	TY1700230	315,00
125/110	780	240	310	230	TY1100231	360,00	TY1700231	315,00
140/63	780	300	300	230	TY1100232	530,00	TY1700232	500,00
140/90	780	300	300	230	TY1100233	530,00	TY1700233	500,00
140/110	780	300	300	230	TY1100234	530,00	TY1700234	500,00
140/125	810	300	300	230	TY1100235	530,00	TY1700235	500,00
160/63	810	310	320	230	TY1100236	570,00	TY1700236	480,00
160/75	810	310	320	230	TY1100237	570,00	TY1700237	480,00
160/90	810	310	320	230	TY1100238	570,00	TY1700238	480,00
160/110	810	310	330	230	TY1100239	570,00	TY1700239	480,00
160/125	810	310	320	230	TY1100240	570,00	TY1700240	480,00
160/140	850	310	320	230	TY1100241	570,00	TY1700241	480,00
180/63	850	320	430	230	TY1100242	800,00	TY1700242	730,00
180/75	850	320	430	230	TY1100243	800,00	TY1700243	730,00
180/90	850	320	440	230	TY1100244	800,00	TY1700244	720,00
180/110	850	320	440	230	TY1100245	800,00	TY1700245	720,00
180/125	850	320	430	230	TY1100246	800,00	TY1700246	720,00
180/140	850	320	430	230	TY1100247	800,00	TY1700247	720,00
180/160	850	320	320	230	TY1100248	800,00	TY1700248	640,00
200/63	870	330	420	230	TY1100249	1 180,00	TY1700249	1 050,00
200/75	870	330	420	230	TY1100250	1 180,00	TY1700250	1 050,00
200/90	870	330	430	230	TY1100251	1 180,00	TY1700251	1 020,00
200/110	870	330	430	230	TY1100252	1 170,00	TY1700252	1 020,00
200/125	870	330	420	230	TY1100253	1 170,00	TY1700253	1 050,00
200/140	870	330	420	230	TY1100254	1 170,00	TY1700254	1 140,00
200/160	870	330	350	230	TY1100255	1 100,00	TY1700255	880,00
200/180	870	330	300	230	TY1100256	1 100,00	TY1700256	850,00

* PE100RC dostępne na zapytanie

Trójnik segmentowy PE100 kołnierzowy 90°

d	d1DN	L [±10]	L [±10]	SDR11		SDR17	
				index	cena	index	cena
90	90/80	430	340	TK1100090	265,00	TK1700090	240,00
110	110/100	430	340	TK1100110	365,00	TK1700110	306,00
125	125/100	490	380	TK1100125	475,00	TK1700125	390,00
140	140/125	500	360	TK1100140	500,00	TK1700140	430,00
160	160/150	560	425	TK1100160	650,00	TK1700160	520,00
180	180/150	600	445	TK1100180	960,00	TK1700180	700,00
200	200/200	620	445	TK1100200	1 100,00	TK1700200	820,00
225	225/200	680	485	TK1100225	1 350,00	TK1700225	970,00
250	250/250	820	550	TK1100250	1 750,00	TK1700250	1 430,00
280	280/250	860	570	TK1100280	2 250,00	TK1700280	1 610,00
315	315/300	1000	640	TK1100315	2 750,00	TK1700315	2 040,00
355	355/350	1120	670	TK1100355	4 100,00	TK1700355	3 360,00
400	400/400	1200	720	TK1100400	5 850,00	TK1700400	4 400,00
450	450/500	1330	785	TK1100450	8 800,00	TK1700450	6 800,00
500	500/500	1480	860	TK1100500	12 300,00	TK1700500	8 900,00
560	560/600	1660	940	TK1100560	17 100,00	TK1700560	11 800,00
630	630/600	1730	970	TK1100630	21 200,00	TK1700630	14 700,00

* PE100RC dostępne na zapytanie

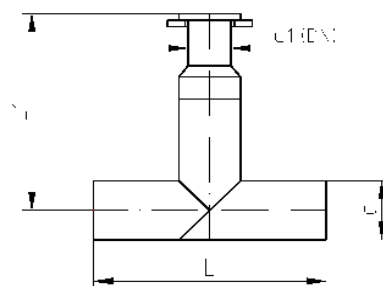

Trójnik segmentowy redukcyjny PE100 kołnierzowy 90°

d/d1	L [±10]	L1 [±10]	SDR11		SDR17	
			index	cena	index	cena
90/63	430	435	TU1100001	290,00	TU1700001	255,00
90/75	430	445	TU1100002	290,00	TU1700002	255,00
110/63	430	445	TU1100003	330,00	TU1700003	285,00
110/75	430	440	TU1100004	330,00	TU1700004	285,00
110/90	430	455	TU1100005	355,00	TU1700005	305,00
125/63	490	455	TU1100006	380,00	TU1700006	330,00
125/75	490	460	TU1100007	380,00	TU1700007	330,00
125/90	490	475	TU1100008	420,00	TU1700008	365,00
125/110	490	475	TU1100009	440,00	TU1700009	365,00
140/63	500	465	TU1100010	460,00	TU1700010	320,00
140/90	500	485	TU1100011	445,00	TU1700011	365,00
140/110	500	485	TU1100012	460,00	TU1700012	405,00
140/125	500	495	TU1100013	460,00	TU1700013	405,00
160/63	560	490	TU1100014	570,00	TU1700014	480,00
160/75	560	495	TU1100015	570,00	TU1700015	480,00
160/90	560	525	TU1100016	560,00	TU1700016	485,00
160/110	560	525	TU1100017	600,00	TU1700017	510,00
160/125	560	535	TU1100018	600,00	TU1700018	510,00
160/140	560	510	TU1100019	600,00	TU1700019	510,00
180/63	600	495	TU1100020	815,00	TU1700020	680,00

* PE100RC dostępne na zapytanie

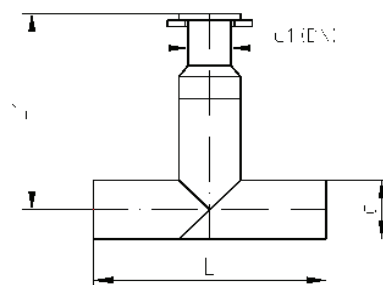

Trójnik segmentowy redukcyjny PE100 kołnierzowy 90°

d/d1	L [±10]	L1 [±10]	SDR11		SDR17	
			index	cena	index	cena
180/75	600	500	TU1100021	815,00	TU1700021	680,00
180/90	600	645	TU1100022	715,00	TU1700022	630,00
180/110	600	645	TU1100023	785,00	TU1700023	710,00
180/125	600	655	TU1100024	785,00	TU1700024	710,00
180/140	600	630	TU1100025	785,00	TU1700025	710,00
180/160	600	550	TU1100026	875,00	TU1700026	640,00
200/63	620	655	TU1100027	1 130,00	TU1700027	935,00
200/75	620	660	TU1100028	1 130,00	TU1700028	935,00
200/90	620	680	TU1100029	965,00	TU1700029	850,00
200/110	620	680	TU1100030	1 030,00	TU1700030	925,00
200/125	620	690	TU1100031	1 030,00	TU1700031	930,00
200/140	620	665	TU1100032	1 030,00	TU1700032	930,00
200/160	620	580	TU1100033	1 075,00	TU1700033	940,00
200/180	620	540	TU1100034	1 075,00	TU1700034	950,00
225/63	680	690	TU1100035	1 245,00	TU1700035	1 120,00
225/75	680	695	TU1100036	1 245,00	TU1700036	1 120,00
225/90	680	715	TU1100037	1 205,00	TU1700037	1 125,00
225/110	680	715	TU1100038	1 285,00	TU1700038	1 175,00
225/125	680	700	TU1100039	1 285,00	TU1700039	1 180,00
225/140	680	700	TU1100040	1 285,00	TU1700040	1 180,00
225/160	680	615	TU1100041	1 320,00	TU1700041	1 130,00
225/180	680	570	TU1100042	1 320,00	TU1700042	1 130,00
225/200	680	560	TU1100043	1 240,00	TU1700043	910,00
250/63	820	655	TU1100044	1 510,00	TU1700044	1 330,00
250/75	820	660	TU1100045	1 510,00	TU1700045	1 330,00
250/90	820	675	TU1100046	1 470,00	TU1700046	1 270,00
250/110	820	675	TU1100047	1 530,00	TU1700047	1 330,00
250/125	820	685	TU1100048	1 530,00	TU1700048	1 330,00
250/140	820	660	TU1100049	1 530,00	TU1700049	1 360,00
250/160	820	680	TU1100050	1 550,00	TU1700050	1 270,00
250/180	820	740	TU1100051	1 550,00	TU1700051	1 280,00
250/200	820	635	TU1100052	1 585,00	TU1700052	1 450,00
250/225	820	645	TU1100053	1 585,00	TU1700053	1 450,00
280/63	860	875	TU1100054	1 965,00	TU1700054	1 700,00
280/75	860	880	TU1100055	1 965,00	TU1700055	1 700,00
280/90	860	905	TU1100056	1 965,00	TU1700056	1 730,00
280/110	860	905	TU1100057	1 985,00	TU1700057	1 795,00
280/125	860	915	TU1100058	1 985,00	TU1700058	1 800,00
280/140	860	890	TU1100059	1 985,00	TU1700059	1 800,00
280/160	860	800	TU1100060	1 965,00	TU1700060	1 780,00
280/180	860	760	TU1100061	1 965,00	TU1700061	1 780,00
280/200	860	750	TU1100062	2 100,00	TU1700062	1 740,00
280/225	860	625	TU1100063	2 100,00	TU1700063	1 740,00
280/250	860	640	TU1100064	2 050,00	TU1700064	1 550,00
315/63	1000	995	TU1100065	2 500,00	TU1700065	2 120,00

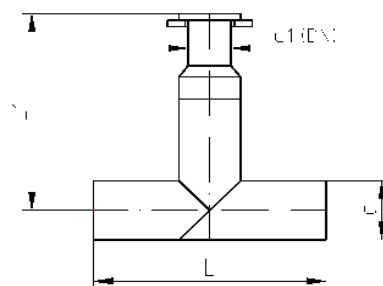

* PE100RC dostępne na zapytanie

Trójnik segmentowy redukcyjny PE100 kołnierzowy 90°

d/d1	L [±10]	L1 [±10]	SDR11		SDR17	
			index	cena	index	cena
315/75	1000	1000	TU1100066	2 500,00	TU1700066	2 120,00
315/90	1000	1015	TU1100067	2 500,00	TU1700067	2 055,00
315/110	1000	1015	TU1100068	2 560,00	TU1700068	2 115,00
315/125	1000	1020	TU1100069	2 560,00	TU1700069	2 115,00
315/140	1000	1010	TU1100070	2 560,00	TU1700070	2 115,00
315/160	1000	910	TU1100071	2 575,00	TU1700071	2 080,00
315/180	1000	880	TU1100072	2 575,00	TU1700072	2 080,00
315/200	1000	870	TU1100073	2 580,00	TU1700073	2 220,00
315/225	1000	790	TU1100074	2 580,00	TU1700074	2 220,00
315/250	1000	740	TU1100075	2 575,00	TU1700075	2 425,00
315/280	1000	690	TU1100076	2 575,00	TU1700076	2 425,00
355/63	1120	1115	TU1100077	4 550,00	TU1700077	3 900,00
355/75	1120	1120	TU1100078	4 550,00	TU1700078	3 900,00
355/90	1120	1140	TU1100079	4 550,00	TU1700079	3 900,00
355/110	1120	1140	TU1100080	4 550,00	TU1700080	4 050,00
355/125	1120	1150	TU1100081	4 550,00	TU1700081	4 050,00
355/140	1120	1125	TU1100082	4 550,00	TU1700082	4 050,00
355/160	1120	1050	TU1100083	4 500,00	TU1700083	3 920,00
355/180	1120	1020	TU1100084	4 500,00	TU1700084	3 920,00
355/200	1120	1010	TU1100085	4 300,00	TU1700085	3 555,00
355/225	1120	920	TU1100086	4 300,00	TU1700086	3 555,00
355/250	1120	880	TU1100087	4 450,00	TU1700087	3 755,00
355/280	1120	840	TU1100088	4 450,00	TU1700088	3 755,00
355/315	1120	750	TU1100089	4 340,00	TU1700089	3 435,00
400/63	1120	1205	TU1100090	6 050,00	TU1700090	5 400,00
400/75	1120	1210	TU1100091	6 050,00	TU1700091	5 400,00
400/90	1120	1235	TU1100092	6 010,00	TU1700092	5 150,00
400/110	1200	1235	TU1100093	5 950,00	TU1700093	5 220,00
400/125	1200	1245	TU1100094	5 950,00	TU1700094	5 220,00
400/140	1200	1220	TU1100095	5 950,00	TU1700095	5 220,00
400/160	1200	1140	TU1100096	6 040,00	TU1700096	5 150,00
400/180	1200	1100	TU1100097	6 040,00	TU1700097	5 150,00
400/200	1200	1090	TU1100098	5 880,00	TU1700098	4 910,00
400/225	1200	1010	TU1100099	5 880,00	TU1700099	4 910,00
400/250	1200	960	TU1100100	6 050,00	TU1700100	5 150,00
400/280	1200	910	TU1100101	6 050,00	TU1700101	5 150,00
400/315	1200	815	TU1100102	5 910,00	TU1700102	4 800,00
400/355	1200	770	TU1100103	6 050,00	TU1700103	5 560,00
450/63	1330	1325	TU1100104	6 459,00	TU1700104	5 753,40
450/75	1330	1335	TU1100105	6 461,80	TU1700105	5 756,50
450/90	1330	1350	TU1100106	6 477,50	TU1700106	5 773,90
450/110	1330	1350	TU1100107	6 486,90	TU1700107	5 784,40
450/125	1330	1360	TU1100108	6 493,10	TU1700108	5 791,40
450/140	1330	1340	TU1100109	6 512,20	TU1700109	5 826,90
450/160	1330	1260	TU1100110	6 485,60	TU1700110	5 783,00

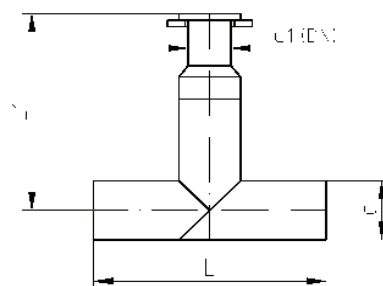

* PE100RC dostępne na zapytanie

Trójnik segmentowy redukcyjny PE100 kołnierzowy 90°

d/d1	L [±10]	L1 [±10]	SDR11		SDR17	
			index	cena	index	cena
450/180	1330	1230	TU1100111	6 432,40	TU1700111	5 723,80
450/200	1330	1220	TU1100112	6 435,90	TU1700112	5 676,70
450/225	1330	1130	TU1100113	6 273,20	TU1700113	5 495,50
450/250	1330	1080	TU1100114	6 323,30	TU1700114	5 535,60
450/280	1330	1030	TU1100115	6 342,00	TU1700115	5 556,50
450/315	1330	970	TU1100116	6 008,30	TU1700116	5 128,90
450/355	1330	900	TU1100117	6 199,70	TU1700117	5 231,00
450/400	1330	845	TU1100118	6 389,20	TU1700118	5 405,30
500/63	1480	1460	TU1100119	11 113,50	TU1700119	7 732,90
500/75	1480	1470	TU1100120	11 116,30	TU1700120	9 178,80
500/90	1480	1490	TU1100121	11 131,90	TU1700121	9 196,20
500/110	1480	1490	TU1100122	11 141,30	TU1700122	9 206,70
500/125	1480	1500	TU1100123	11 147,60	TU1700123	9 213,70
500/140	1480	1475	TU1100124	11 166,70	TU1700124	9 249,20
500/160	1480	1395	TU1100125	11 090,00	TU1700125	9 149,50
500/180	1480	1370	TU1100126	11 036,80	TU1700126	9 090,30
500/200	1480	1360	TU1100127	11 115,30	TU1700127	9 126,90
500/225	1480	1270	TU1100128	10 890,10	TU1700128	8 876,00
500/250	1480	1220	TU1100129	11 002,70	TU1700129	8 985,70
500/280	1480	1170	TU1100130	11 021,50	TU1700130	9 006,60
500/315	1480	1110	TU1100131	10 719,00	TU1700131	8 613,90
500/355	1480	1035	TU1100132	10 910,50	TU1700132	8 716,00
500/400	1480	980	TU1100133	11 068,70	TU1700133	8 855,40
500/450	1480	930	TU1100134	10 291,10	TU1700134	7 945,80
560/63	1660	1620	TU1100135	15 158,00	TU1700135	10 940,60
560/75	1660	1630	TU1100136	15 160,80	TU1700136	10 943,30
560/90	1660	1650	TU1100137	15 176,40	TU1700137	10 553,70
560/110	1660	1650	TU1100138	15 185,80	TU1700138	10 967,90
560/125	1660	1660	TU1100139	15 192,10	TU1700139	10 974,10
560/140	1660	1635	TU1100140	15 211,20	TU1700140	11 005,40
560/160	1660	1550	TU1100141	15 134,50	TU1700141	10 917,50
560/180	1660	1510	TU1100142	15 087,60	TU1700142	10 871,40
560/200	1660	1500	TU1100143	15 166,10	TU1700143	10 903,70
560/225	1660	1420	TU1100144	14 934,60	TU1700144	10 676,10
560/250	1660	1370	TU1100145	15 047,20	TU1700145	10 773,00
560/280	1660	1320	TU1100146	15 066,00	TU1700146	10 791,40
560/315	1660	1260	TU1100147	14 757,30	TU1700147	10 438,70
560/355	1660	1180	TU1100148	14 923,70	TU1700148	10 504,20
560/400	1660	1130	TU1100149	15 113,20	TU1700149	10 658,00
560/450	1660	1060	TU1100150	13 206,40	TU1700150	8 511,60
560/500	1660	1010	TU1100151	13 372,20	TU1700151	8 763,80
630/63	1730	1705	TU1100152	20 319,20	TU1700152	14 882,70
630/75	1730	1715	TU1100153	20 322,00	TU1700153	14 885,50
630/90	1730	1735	TU1100154	20 337,60	TU1700154	14 900,90
630/110	1730	1735	TU1100155	20 347,00	TU1700155	14 910,10

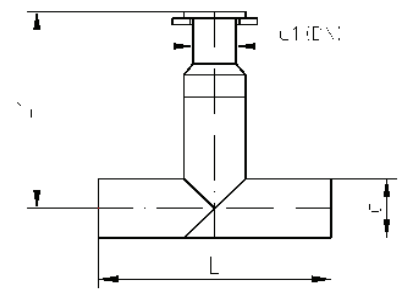

* PE100RC dostępne na zapytanie

Trójnik segmentowy redukcyjny PE100 kołnierzowy 90°

d/d1	L [±10]	L1 [±10]	SDR11		SDR17	
			index	cena	index	cena
630/125	1730	1745	TU1100156	20 353,30	TU1700156	14 916,20
630/140	1730	1720	TU1100157	20 372,40	TU1700157	14 947,60
630/160	1730	1630	TU1100158	20 295,70	TU1700158	14 859,60
630/180	1730	1590	TU1100159	20 242,50	TU1700159	14 807,40
630/200	1730	1580	TU1100160	20 321,10	TU1700160	14 839,70
630/225	1730	1500	TU1100161	20 095,80	TU1700161	14 618,30
630/250	1730	1450	TU1100162	20 208,40	TU1700162	14 715,10
630/280	1730	1400	TU1100163	20 214,70	TU1700163	14 721,30
630/315	1730	1340	TU1100164	19 893,50	TU1700164	14 356,30
630/355	1730	1260	TU1100165	20 084,90	TU1700165	14 446,40
630/400	1730	1230	TU1100166	20 274,40	TU1700166	14 660,00
630/450	1730	1160	TU1100167	16 847,40	TU1700167	10 959,30
630/500	1730	1110	TU1100168	16 609,70	TU1700168	10 814,80
630/560	1730	1030	TU1100169	17 457,40	TU1700169	11 279,10

* PE100RC dostępne na zapytanie

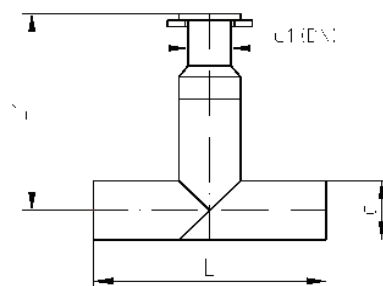

Czwórnik segmentowy PE100

d	L [±10]	L1 [±10]	SDR11		SDR17	
			index	cena	index	cena
110	920	460	CZ1190110	200,00	CZ1790110	180,00
125	1040	520	CZ1190125	245,00	CZ1790125	250,00
140	1060	530	CZ1190140	320,00	CZ1790140	280,00
160	1180	590	CZ1190160	380,00	CZ1790160	350,00
180	1260	630	CZ1190180	530,00	CZ1790180	450,00
200	1300	650	CZ1190200	640,00	CZ1790200	530,00
225	1430	715	CZ1190225	760,00	CZ1790225	620,00
250	1710	855	CZ1190250	1 000,00	CZ1790250	950,00
280	1810	905	CZ1190280	1 250,00	CZ1790280	1 150,00
315	2120	1060	CZ1190315	1 820,00	CZ1790315	1 450,00

* PE100RC dostępne na zapytanie

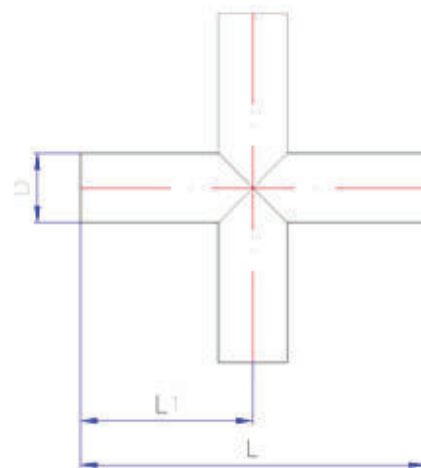

Uskok segmentowy PE100 równoprzelotowy 45°

d/d1	L [±10]	L1 [±10]	H [±10]	SDR11		SDR17	
				index	cena	index	cena
90	650	180	300	US1100090	126,00	US1700090	102,00
110	670	190	300	US1100110	139,00	US1700110	132,00
125	690	190	300	US1100125	182,00	US1700125	160,00
140	700	200	300	US1100140	221,00	US1700140	188,00
160	730	220	300	US1100160	255,00	US1700160	225,00
180	750	230	300	US1100180	355,00	US1700180	310,00
200	810	250	300	US1100200	445,00	US1700200	388,00
225	820	260	300	US1100225	535,00	US1700225	455,00
250	880	290	300	US1100250	720,00	US1700250	595,00
280	920	310	300	US1100280	890,00	US1700280	752,00
315	1000	350	300	US1100315	1 170,00	US1700315	915,00

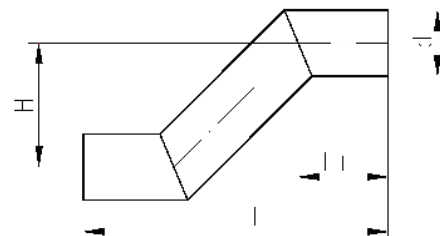

* PE100RC dostępne na zapytanie

Tuleja kołnierzowa PE100 z króćcem

d	L [±10]	L1 [±10]	SDR11		SDR17	
			index	cena	index	cena
250	350	200	YA110250	260,00	YA170250	220,00
280	400	250	YA110280	310,00	YA170280	260,00
315	400	250	YA110315	380,00	YA170315	330,00
355	405	280	YA110355	610,00	YA170355	580,00
400	405	280	YA110400	1 000,00	YA170400	820,00
450	415	280	YA110450	1 400,00	YA170450	1 100,00
500	450	300	YA110500	1 450,00	YA170500	1 200,00
560	450	300	YA110560	1 850,00	YA170560	1 400,00
630	450	300	YA110630	2 100,00	YA170630	1 800,00

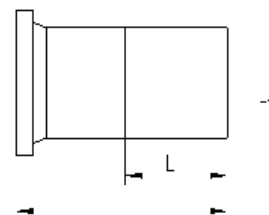

* PE100RC dostępne na zapytanie

Trójnik siodłowy PE100 redukcyjny 90°

d/d1	L [±5]	L1 [±5]	L2 [±5]	SDR11		SDR17	
				index	cena	index	cena
200/63	660	260	65	ST1100001	668,10	ST1700001	614,65
200/75	660	260	70	ST1100002	668,10	ST1700002	614,65
200/90	660	260	80	ST1100003	884,00	ST1700003	813,28
200/110	660	260	90	ST1100004	884,00	ST1700004	813,28
200/125	660	260	100	ST1100005	884,00	ST1700005	813,28
225/63	710	270	65	ST1100006	741,20	ST1700006	681,90
225/75	710	270	70	ST1100007	741,20	ST1700007	681,90
225/90	710	270	80	ST1100008	955,40	ST1700008	878,97
225/110	710	270	90	ST1100009	955,40	ST1700009	878,97
225/125	710	270	100	ST1100010	955,40	ST1700010	878,97
250/63	850	285	65	ST1100011	892,50	ST1700011	821,10
250/75	850	285	70	ST1100012	892,50	ST1700012	821,10
250/90	850	285	80	ST1100013	1 106,70	ST1700013	1 018,16
250/110	850	285	90	ST1100014	1 106,70	ST1700014	1 018,16
250/125	850	285	100	ST1100015	1 106,70	ST1700015	1 018,16
250/140	850	285	90	ST1100016	1 232,50	ST1700016	1 133,90
250/160	850	285	95	ST1100017	1 232,50	ST1700017	1 133,90
280/63	890	300	65	ST1100018	1 008,10	ST1700018	927,45
280/75	890	300	70	ST1100019	1 008,10	ST1700019	927,45
280/90	890	300	80	ST1100020	1 224,00	ST1700020	1 126,08
280/110	890	300	90	ST1100021	1 224,00	ST1700021	1 126,08
280/125	890	300	100	ST1100022	1 224,00	ST1700022	1 126,08
280/140	890	300	90	ST1100023	1 349,80	ST1700023	1 241,82
280/160	890	300	95	ST1100024	1 349,80	ST1700024	1 241,82
315/63	1030	320	65	ST1100025	1 042,10	ST1700025	958,73
315/75	1030	320	70	ST1100026	1 042,10	ST1700026	958,73
315/90	1030	320	80	ST1100027	1 258,00	ST1700027	1 157,36
315/110	1030	320	90	ST1100028	1 258,00	ST1700028	1 157,36
315/125	1030	320	100	ST1100029	1 258,00	ST1700029	1 157,36
315/140	1030	310	90	ST1100030	1 524,90	ST1700030	1 402,91
315/160	1030	310	95	ST1100031	1 524,90	ST1700031	1 402,91
315/180	1030	310	100	ST1100032	1 671,10	ST1700032	1 537,41
315/200	1030	310	110	ST1100033	1 961,80	ST1700033	1 804,86
355/63	1150	335	65	ST1100034	1 275,00	ST1700034	1 173,00
355/75	1150	335	70	ST1100035	1 275,00	ST1700035	1 173,00
355/90	1150	335	80	ST1100036	1 587,80	ST1700036	1 460,78
355/110	1150	335	90	ST1100037	1 587,80	ST1700037	1 460,78
355/125	1150	335	100	ST1100038	1 492,60	ST1700038	1 373,19
355/140	1150	325	90	ST1100039	1 761,20	ST1700039	1 620,30
355/160	1150	325	95	ST1100040	1 761,20	ST1700040	1 620,30
355/180	1150	325	100	ST1100041	1 905,70	ST1700041	1 753,24
355/200	1150	325	110	ST1100042	2 050,20	ST1700042	1 886,18
400/63	1230	360	65	ST1100043	1 686,40	ST1700043	1 551,49
400/75	1230	360	70	ST1100044	1 686,40	ST1700044	1 551,49
400/90	1230	360	80	ST1100045	1 999,20	ST1700045	1 839,26

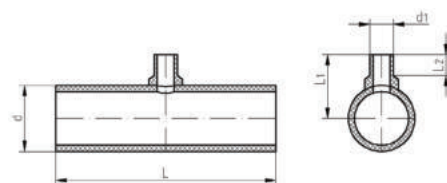

* PE100RC dostępne na zapytanie

Trójnik siodłowy PE100 redukcyjny 90°

d/d1	L [±5]	L1 [±5]	L2 [±5]	SDR11		SDR17	
				index	cena	index	cena
400/110	1230	360	90	ST1100046	1 999,20	ST1700046	1 839,26
400/125	1230	360	100	ST1100047	1 904,00	ST1700047	1 751,68
400/140	1230	350	90	ST1100048	2 172,60	ST1700048	1 998,79
400/160	1230	350	95	ST1100049	2 172,60	ST1700049	1 998,79
400/180	1230	350	100	ST1100050	2 317,10	ST1700050	2 131,73
400/200	1230	350	110	ST1100051	2 699,60	ST1700051	2 483,63
450/63	1350	385	65	ST1100052	2 261,00	ST1700052	2 080,12
450/75	1350	385	70	ST1100053	2 261,00	ST1700053	2 080,12
450/90	1350	385	80	ST1100054	2 570,40	ST1700054	2 364,77
450/110	1350	385	90	ST1100055	2 570,40	ST1700055	2 364,77
450/125	1350	385	100	ST1100056	2 475,20	ST1700056	2 277,18
450/140	1350	375	90	ST1100057	2 743,80	ST1700057	2 524,30
450/160	1350	375	95	ST1100058	2 743,80	ST1700058	2 524,30
450/180	1350	375	100	ST1100059	2 983,50	ST1700059	2 744,82
450/200	1350	375	110	ST1100060	3 274,20	ST1700060	3 012,26
500/63	1500	410	65	ST1100061	2 956,30	ST1700061	2 719,80
500/75	1500	410	70	ST1100062	2 956,30	ST1700062	2 719,80
500/90	1500	410	80	ST1100063	3 267,40	ST1700063	3 006,01
500/110	1500	410	90	ST1100064	3 267,40	ST1700064	3 006,01
500/125	1500	410	100	ST1100065	3 170,50	ST1700065	2 916,86
500/140	1500	400	90	ST1100066	3 439,10	ST1700066	3 163,97
500/160	1500	400	95	ST1100067	3 439,10	ST1700067	3 163,97
500/180	1500	400	100	ST1100068	3 678,80	ST1700068	3 384,50
500/200	1500	400	110	ST1100069	3 967,80	ST1700069	3 650,38
560/63	1670	440	65	ST1100070	4 304,40	ST1700070	3 960,05
560/75	1670	440	70	ST1100071	4 304,40	ST1700071	3 960,05
560/90	1670	440	80	ST1100072	4 613,80	ST1700072	4 244,70
560/110	1670	440	90	ST1100073	4 613,80	ST1700073	4 244,70
560/125	1670	440	100	ST1100074	4 518,60	ST1700074	4 157,11
560/140	1670	430	90	ST1100075	4 787,20	ST1700075	4 404,22
560/160	1670	430	95	ST1100076	4 787,20	ST1700076	4 404,22
560/180	1670	430	100	ST1100077	5 026,90	ST1700077	4 624,75
560/200	1670	430	110	ST1100078	5 315,90	ST1700078	4 890,63
630/63	1750	475	65	ST1100079	5 851,40	ST1700079	5 383,29
630/75	1750	475	70	ST1100080	5 851,40	ST1700080	5 383,29
630/90	1750	475	80	ST1100081	6 162,50	ST1700081	5 669,50
630/110	1750	475	90	ST1100082	6 162,50	ST1700082	5 669,50
630/125	1750	475	100	ST1100083	6 069,00	ST1700083	5 583,48
630/140	1750	465	90	ST1100084	6 337,60	ST1700084	5 830,59
630/160	1750	465	95	ST1100085	6 337,60	ST1700085	5 830,59
630/180	1750	465	100	ST1100086	6 568,80	ST1700086	6 043,30
630/200	1750	465	110	ST1100087	6 873,10	ST1700087	6 323,25

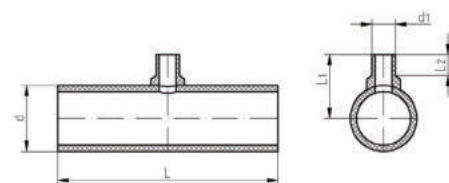

* PE100RC dostępne na zapytanie

Trójnik siodłowy PE100 redukcyjny 90° kołnierzowy

d/d1	L [±10]	L1 [±10]	SDR11		SDR17	
			index	cena	index	cena
200/63	660	380	SK1100001	835,13	SK1700001	768,32
200/75	660	380	SK1100002	835,13	SK1700002	768,32
200/90	660	400	SK1100003	1 105,00	SK1700003	1 016,60
200/110	660	400	SK1100004	1 105,00	SK1700004	1 016,60
200/125	660	410	SK1100005	1 105,00	SK1700005	1 016,60
225/63	710	365	SK1100006	926,50	SK1700006	852,38
225/75	710	390	SK1100007	926,50	SK1700007	852,38
225/90	710	410	SK1100008	1 194,25	SK1700008	1 098,71
225/110	710	410	SK1100009	1 194,25	SK1700009	1 098,71
225/125	710	420	SK1100010	1 194,25	SK1700010	1 098,71
250/63	850	400	SK1100011	1 115,63	SK1700011	1 026,38
250/75	850	405	SK1100012	1 115,63	SK1700012	1 026,38
250/90	850	425	SK1100013	1 383,38	SK1700013	1 272,71
250/110	850	425	SK1100014	1 383,38	SK1700014	1 272,71
250/125	850	435	SK1100015	1 383,38	SK1700015	1 272,71
250/140	850	410	SK1100016	1 540,63	SK1700016	1 417,38
250/160	850	445	SK1100017	1 540,63	SK1700017	1 417,38
280/63	890	415	SK1100018	1 260,13	SK1700018	1 159,32
280/75	890	420	SK1100019	1 260,13	SK1700019	1 159,32
280/90	890	440	SK1100020	1 530,00	SK1700020	1 407,60
280/110	890	440	SK1100021	1 530,00	SK1700021	1 407,60
280/125	890	450	SK1100022	1 530,00	SK1700022	1 407,60
280/140	890	425	SK1100023	1 687,25	SK1700023	1 552,27
280/160	890	460	SK1100024	1 687,25	SK1700024	1 552,27
315/63	1030	435	SK1100025	1 302,63	SK1700025	1 198,42
315/75	1030	440	SK1100026	1 302,63	SK1700026	1 198,42
315/90	1030	460	SK1100027	1 572,50	SK1700027	1 446,70
315/110	1030	460	SK1100028	1 572,50	SK1700028	1 446,70
315/125	1030	470	SK1100029	1 572,50	SK1700029	1 446,70
315/140	1030	445	SK1100030	1 906,13	SK1700030	1 753,64
315/160	1030	470	SK1100031	1 906,13	SK1700031	1 753,64
315/180	1030	470	SK1100032	2 088,88	SK1700032	1 921,77
315/200	1030	460	SK1100033	2 452,25	SK1700033	2 256,07
355/63	1150	450	SK1100034	1 593,75	SK1700034	1 466,25
355/75	1150	455	SK1100035	1 593,75	SK1700035	1 466,25
355/90	1150	475	SK1100036	1 984,75	SK1700036	1 825,97
355/110	1150	475	SK1100037	1 984,75	SK1700037	1 825,97
355/125	1150	485	SK1100038	1 865,75	SK1700038	1 716,49
355/140	1150	450	SK1100039	2 201,50	SK1700039	2 025,38
355/160	1150	485	SK1100040	2 201,50	SK1700040	2 025,38
355/180	1150	485	SK1100041	2 382,13	SK1700041	2 191,56
355/200	1150	475	SK1100042	2 562,75	SK1700042	2 357,73
400/63	1230	475	SK1100043	2 108,00	SK1700043	1 939,36
400/75	1230	480	SK1100044	2 108,00	SK1700044	1 939,36
400/90	1230	500	SK1100045	2 499,00	SK1700045	2 299,08

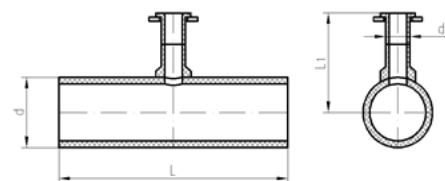

* PE100RC dostępne na zapytanie

Trójnik siodłowy PE100 redukcyjny 90° kołnierzowy

d/d1	L [±10]	L1 [±10]	SDR11		SDR17	
			index	cena	index	cena
400/110	1230	500	SK1100046	2 499,00	SK1700046	2 299,08
400/125	1230	510	SK1100047	2 380,00	SK1700047	2 189,60
400/140	1230	485	SK1100048	2 715,75	SK1700048	2 498,49
400/160	1230	510	SK1100049	2 715,75	SK1700049	2 498,49
400/180	1230	510	SK1100050	2 896,38	SK1700050	2 664,67
400/200	1230	500	SK1100051	3 374,50	SK1700051	3 104,54
450/63	1350	535	SK1100052	2 826,25	SK1700052	2 600,15
450/75	1350	535	SK1100053	2 826,25	SK1700053	2 600,15
450/90	1350	525	SK1100054	3 213,00	SK1700054	2 955,96
450/110	1350	525	SK1100055	3 213,00	SK1700055	2 955,96
450/125	1350	535	SK1100056	3 094,00	SK1700056	2 846,48
450/140	1350	500	SK1100057	3 429,75	SK1700057	3 155,37
450/160	1350	535	SK1100058	3 429,75	SK1700058	3 155,37
450/180	1350	535	SK1100059	3 729,38	SK1700059	3 431,03
450/200	1350	525	SK1100060	4 092,75	SK1700060	3 765,33
500/63	1500	525	SK1100061	3 695,38	SK1700061	3 399,75
500/75	1500	530	SK1100062	3 695,38	SK1700062	3 399,75
500/90	1500	550	SK1100063	4 084,25	SK1700063	3 757,51
500/110	1500	550	SK1100064	4 084,25	SK1700064	3 757,51
500/125	1500	560	SK1100065	3 963,13	SK1700065	3 646,08
500/140	1500	525	SK1100066	4 298,88	SK1700066	3 954,97
500/160	1500	560	SK1100067	4 298,88	SK1700067	3 954,97
500/180	1500	550	SK1100068	4 598,50	SK1700068	4 230,62
500/200	1500	555	SK1100069	4 959,75	SK1700069	4 562,97
560/63	1670	560	SK1100070	5 380,50	SK1700070	4 950,06
560/75	1670	580	SK1100071	5 380,50	SK1700071	4 950,06
560/90	1670	580	SK1100072	5 767,25	SK1700072	5 305,87
560/110	1670	580	SK1100073	5 767,25	SK1700073	5 305,87
560/125	1670	590	SK1100074	5 648,25	SK1700074	5 196,39
560/140	1670	590	SK1100075	5 984,00	SK1700075	5 505,28
560/160	1670	555	SK1100076	5 984,00	SK1700076	5 505,28
560/180	1670	590	SK1100077	6 283,63	SK1700077	5 780,94
560/200	1670	580	SK1100078	6 644,88	SK1700078	6 113,29
630/63	1750	590	SK1100079	7 314,25	SK1700079	6 729,11
630/75	1750	595	SK1100080	7 314,25	SK1700080	6 729,11
630/90	1750	615	SK1100081	7 703,13	SK1700081	7 086,88
630/110	1750	615	SK1100082	7 703,13	SK1700082	7 086,88
630/125	1750	625	SK1100083	7 586,25	SK1700083	6 979,35
630/140	1750	590	SK1100084	7 922,00	SK1700084	7 288,24
630/160	1750	625	SK1100085	7 922,00	SK1700085	7 288,24
630/180	1750	625	SK1100086	8 211,00	SK1700086	7 554,12
630/200	1750	615	SK1100087	8 591,38	SK1700087	7 904,07

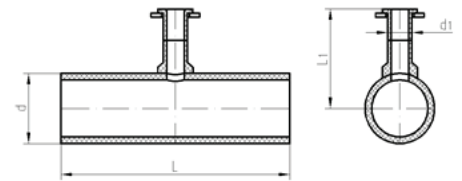

* PE100RC dostępne na zapytanie



ZINPLAS
ul. 240 Wiosna, ul. 60
www.zin.pl
ZASLEPIE
Woda SDR17
Data produkcji
Pobita Norma: PN-89
Kodowa Grupa
Wielkość (Długość)

02

.....

Kształtki wtryskowe doczołowe

Do wody i kanalizacji ciśnieniowej
PE100

.....



.....

www.zinplast.pl

Kształtki wtryskowe doczołowe do wody i kanalizacji ciśnieniowej PE100

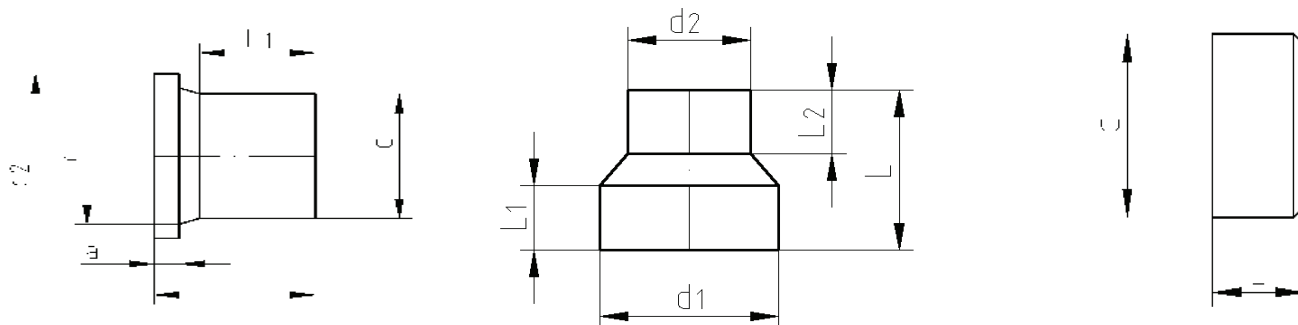

Specyfikacja techniczna

Budowa kształtki:	Tuleje, redukcje, zaślepki – gładkie jednowarstwowe
Przeznaczenie:	Kształtki polietylenowe przeznaczone do przesyłania wody i kanalizacji ciśnieniowej
Kolor:	Czarny
Normy produktu:	PN-EN 12201-3+A1
Materiał:	PE 100, PE 100 RC
Wymiary:	Ø50 do Ø630; SDR 11, SDR 17
Klasyfikacja statystyczna wyrobu:	PKWiU 25.21-21-53-10
Forma dostawy:	Pakowane zbiorczo lub osobno w opakowania kartonowe lub foliowe
Dopuszczenia:	Aktualne dokumenty odniesienia znajdują się na stronie www.zinplast.pl

Tuleja kołnierzowa PE100 długa

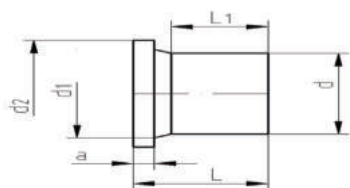

d	L [±5]	L1 [±5]	d1 [-2]	d2 [-1]	SDR11			SDR17		
					a [+2]	index	cena	a [+2]	index	cena
50	95	65	61	88	12	TW1100050	17,00	12	TW1700050	17,00
63	115	70	75	102	14	TW1100063	18,00	14	TW1700063	18,00
75	120	80	89	122	16	TW1100075	22,00	16	TW1700075	21,00
90	140	95	105	138	17	TW1100090	27,50	17	TW1700090	24,00
110	155	100	125	158	18	TW1100110	34,00	18	TW1700110	28,00
125	142	120	125	158	25	TW1100125	46,00	18	TW1700125	38,00
140	160	105	155	188	25	TW1100140	52,00	18	TW1700140	51,00
160	160	115	175	212	25	TW1100160	55,00	18	TW1700160	52,00
180	150	120	180	212	30	TW1100180	89,00	20	TW1700180	88,00
200	200	135	232	268	-	-	-	24	TW1700200	108,00
225	200	135	235	268	-	-	-	24	TW1700225	118,00
355	250	180	373	430	-	-	-	30	TW1700355	530,00

Tuleja kołnierzowa PE100 krótka

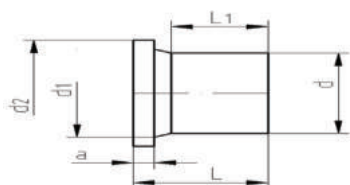

d	L [±5]	L1 [±5]	d1 [-2]	d2 [-1]	SDR11			SDR17		
					a [+2]	index	cena	a [+2]	index	cena
200	140	85	232	268	32	TW1110200	112,00	24	TW1700200	106,00
225	150	95	235	268	32	TW1110225	124,00	24	TW1700225	116,00
250	150	85	285	320	35	TW1100250	187,00	25	TW1700250	160,00
280	155	105	291	320	35	TW1100280	250,00	25	TW1700280	220,00
315	155	90	335	370	35	TW1100315	300,00	25	TW1700315	240,00
355	125	75	373	430	40	TW1110355	590,00	30	TW1700355	510,00
400	125	70	427	482	46	TW1100400	700,00	34	TW1700400	800,00
450/450	135	65	472	530	46	TW1100451	1 400,00	46	TW1700451	1 000,00
450	135	65	514	585	60	TW1100450	1 000,00	46	TW1700450	1 000,00
500	150	70	530	585	60	TW1100500	1 050,00	46	TW1700500	1 050,00
560	150	70	615	685	60	TW1100560	1 150,00	50	TW1700560	1 350,00
630	145	75	642	685	60	TW1100630	1 250,00	50	TW1700630	1 500,00

Redukcja centryczna PE100 wtryskowa

d/d1	L [±5]	L1 [±5]	L2 [±5]	SDR11		SDR17	
				index	cena	index	cena
90/63	130	50	55	RW1100001	40,00	RW1700001	40,00
90/75	130	45	55	RW1100002	40,00	RW1700002	40,00
110/63	140	50	60	RW1100003	42,00	RW1700003	41,00
110/75	135	45	60	RW1100004	42,00	RW1700004	41,00
110/90	135	50	60	RW1100005	43,00	RW1700005	41,00
125/63	120	40	45	RW1100006	64,00	RW1700006	55,00
125/75	120	40	50	RW1100007	64,00	RW1700007	55,00
125/90	120	40	50	RW1100008	64,00	RW1700008	55,00
125/110	120	40	50	RW1100009	65,00	RW1700009	57,00
140/63	135	50	50	RW1100010	85,00	RW1700010	70,00
140/90	135	50	50	RW1100011	85,00	RW1700011	72,00
140/110	135	50	50	RW1100012	88,00	RW1700012	72,00
140/125	135	50	50	RW1100013	88,00	RW1700013	72,00
160/63	135	50	50	RW1100014	120,00	RW1700014	90,00
160/75	135	50	50	RW1100015	120,00	RW1700015	95,00
160/90	130	45	45	RW1100016	120,00	RW1700016	95,00
160/110	150	55	60	RW1100017	120,00	RW1700017	95,00
160/125	135	50	50	RW1100018	120,00	RW1700018	105,00
160/140	135	50	50	RW1100019	120,00	RW1700019	105,00
180/160	115	50	60	RW1100020	145,00	RW1700020	130,00
200/160	145	55	50	RW1100021	145,00	RW1700021	125,00
200/180	145	55	50	RW1100022	185,00	RW1700022	175,00
225/160	115	50	40	RW1100023	185,00	RW1700023	175,00
225/180	115	50	40	RW1100024	195,00	RW1700024	180,00
225/200	110	50	50	RW1100025	195,00	RW1700025	180,00
250/160	155	50	60	RW1100026	250,00	RW1700026	220,00
250/200	120	50	50	RW1100027	250,00	RW1700027	220,00
250/225	115	50	55	RW1100028	250,00	RW1700028	235,00
280/225	135	40	30	RW1100029	350,00	RW1700029	280,00
280/250	80	30	30	RW1100030	350,00	RW1700030	285,00
315/225	175	35	30	RW1100031	350,00	RW1700031	310,00
315/250	130	35	30	RW1100032	350,00	RW1700032	320,00
315/280	80	35	30	RW1100033	350,00	RW1700033	340,00
355/315	100	45	30	RW1100034	600,00	RW1700034	550,00
400/315	150	45	30	RW1100035	620,00	RW1700035	650,00
400/355	95	45	30	RW1100036	640,00	RW1700036	750,00
450/315	200	45	30	RW1100037	660,00	RW1700037	900,00
450/355	150	45	30	RW1100038	680,00	RW1700038	950,00
450/400	95	45	30	RW1100039	750,00	RW1700039	1 200,00
500/450	90	35	30	RW1100040	1 800,00	RW1700040	1 800,00
560/450	115	35	30	RW1100041	2 100,00	RW1700041	2 100,00
560/500	90	35	30	RW1100042	2 200,00	RW1700042	2 200,00
630/450	180	40	30	RW1100043	3 500,00	RW1700043	3 500,00
630/500	125	40	25	RW1100044	3 700,00	RW1700044	3 700,00
630/560	85	40	25	RW1100045	3 900,00	RW1700045	3 900,00

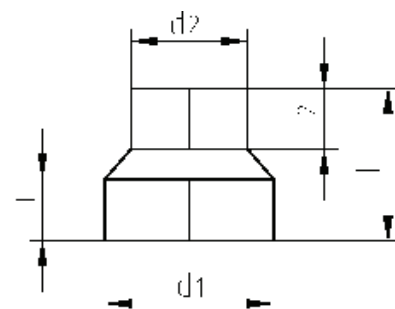

Zaślepka PE100 wtryskowa

d/d1	L1 [±5]	SDR11		SDR17	
		index	cena	index	cena
90	55	ZW1100090	30,00	ZW1700090	28,00
110	60	ZW1100110	42,00	ZW1700110	33,50
125	50	ZW1100125	50,00	ZW1700125	44,50
140	50	ZW1100140	70,00	ZW1700140	90,00
160	85	ZW1100160	85,00	ZW1700160	75,00
180	65	ZW1100180	125,00	ZW1700180	140,00
200	60	ZW1100200	130,00	ZW1700200	150,00
225	65	ZW1100225	150,50	ZW1700225	160,00
250	65	ZW1100250	150,50	ZW1700250	200,00
280	60	ZW1100280	245,00	ZW1700280	250,00
315	60	ZW1100315	250,00	ZW1700315	290,00

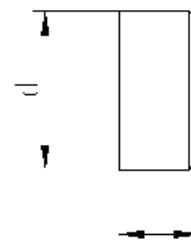

03

.....
Akcesoria
.....

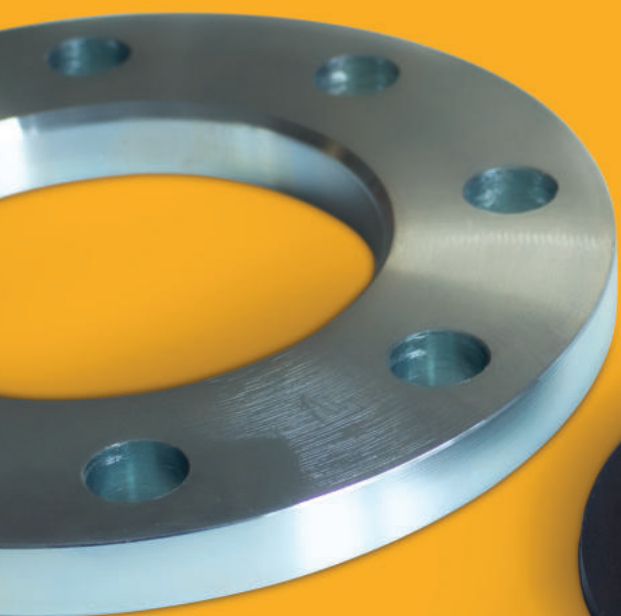

.....
www.zinplast.pl

Złącze adapter PE/mosiądz z gwintem zewnętrznym (GZ)**PE100/SDR 11****Woda 16 bar, Gaz 10 bar**

Kod	cena
20 x ½	62,00
25 x ¾	63,00
32 x ¾	110,00
32 x 1	80,00
32 x 1 ½	160,00
40 x 1	115,00
40 x 1 ¼	115,00
50 x 1 ½	145,00
50 x 2	180,00
63 x 1 ½	200,00
63 x 2	170,00
75 x 2 ½	310,00
90 x 3	400,00
110 x 4	635,00

**Złącze adapter PE/mosiądz z gwintem wewnętrznym (GW)****PE100/SDR 11****Woda 16 bar, Gaz 10 bar**

Kod	cena
20 x ½	62,00
25 x ¾	63,00
32 x 1	80,00
40 x 1	115,00
40 x 1 ¼	115,00
50 x 1 ½	145,00
63 x 1 ½	200,00
63 x 2	170,00
75 x 2 ½	310,00
90 x 3	400,00
110 x 4	635,00



Kołnierze stalowe galwanizowane

PN16								
DN/d	Dz	Dw	Dp	B	dp	ilość otworów	index	cena
40/50	150	63	110	16	18	4	GE1600001	56,00
50/63	165	78	125	16	18	4	GE1600002	63,00
65/75	185	92	145	16	18	4	GE1600003	73,00
80/90	200	108	160	18	18	8	GE1600004	91,00
100/110	220	135	180	18	18	8	GE1600005	107,00
100/125	220	135	180	18	18	8	GE1600006	100,00
125/125	250	135	210	18	18	8	GE1600007	144,00
125/140	250	158	210	18	18	8	GE1600008	125,00
150/160	285	175	240	20	22	8	GE1600009	162,00
150/180	285	185	240	20	22	8	GE1600010	149,00
200/200	340	236	295	20	22	12	GE1600011	236,00
200/225	340	238	295	20	22	12	GE1600012	239,00
250/250	405	289	355	29	26	12	GE1600013	393,00
250/280	405	295	355	29	26	12	GE1600014	287,00
300/315	460	339	410	34	26	12	GE1600015	569,00
350/355	520	377	470	39	26	16	GE1600016	844,00
400/400	580	421	525	41	30	16	GE1600017	936,00
450/450	670	517	585	42	33	20	GE1600018	1136,00
500/450	715	517	650	42	33	20	GE1600019	1400,00
500/500	715	533	650	42	33	20	GE1600020	1449,00
600/560	840	618	770	48	33	20	GE1600021	2799,00
600/630	840	645	770	48	33	20	GE1600022	3800,00

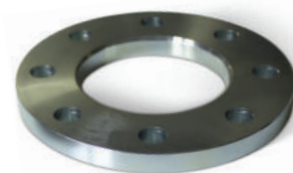

PN10								
DN/d	Dz	Dw	Dp	B	dp	ilość otworów	index	cena
40/50	150	63	110	16	18	4	GE1000001	56,00
50/63	165	78	125	16	18	4	GE1000002	63,00
65/75	185	92	145	16	18	4	GE1000003	73,00
80/90	200	108	160	18	18	8	GE1000004	91,00
100/110	220	128	180	18	18	8	GE1000005	107,00
100/125	220	128	180	18	18	8	GE1000006	100,00
125/125	250	135	210	18	18	8	GE1000007	144,00
125/140	250	158	210	18	18	8	GE1000008	125,00
150/160	285	178	240	20	22	8	GE1000009	162,00
150/180	285	178	240	20	22	8	GE1000010	149,00
200/200	340	236	295	20	22	12	GE1000011	236,00
200/225	340	238	295	20	22	12	GE1000012	239,00
250/250	395	289	350	24	22	12	GE1000013	393,00
250/280	395	295	350	28	22	12	GE1000014	287,00
300/315	445	339	400	28	22	12	GE1000015	569,00
350/355	505	377	460	30	22	16	GE1000016	844,00
400/400	565	421	515	32	26	16	GE1000017	936,00
450/450	615	470	565	35	26	20	GE1000018	1136,00
500/450	670	517	620	38	26	20	GE1000019	1400,00
500/500	670	533	620	38	26	20	GE1000020	1449,00
600/560	780	618	725	44	30	20	GE1000021	2799,00
600/630	780	645	725	44	30	20	GE1000022	3800,00



Uszczelka gumowa płaska

DN	index	cena
40	UD0000040	2,00
50	UD0000050	2,00
65	UD0000065	3,00
80	UD0000080	3,00
100	UD0000100	4,00
125	UD0000125	5,00
150	UD0000150	6,00
200	UD0000200	9,00
250	UD0000250	11,00
300	UD0000300	15,00
350	UD0000350	19,00
400	UD0000400	31,00
500	UD0000500	46,00
600	UD0000600	80,00



Uszczelka z wkładką stalową

DN	index	cena
32	UGWS00032	24,00
40	UGWS00040	24,00
50	UGWS00050	25,00
65	UGWS00065	28,00
80	UGWS00080	31,00
100	UGWS00100	32,00
125	UGWS00125	38,00
150	UGWS00150	45,00
200	UGWS00200	64,00
250	UGWS00250	79,00
300	UGWS00300	116,00
350	UGWS00350	160,00
400	UGWS00400	190,00
500	UGWS00500	268,00
600	UGWS00600	355





Skontaktuj się z naszym doradcą:

Kształtki

Mariusz Kurta

m. +48 532 065 255

email. mariusz.kurta@zinplast.pl

Kształtki

Anna Mydlarczyk

m. +48 789 315 444

email. kształtki@zinplast.pl

Lub skontaktuj się z przedstawicielem regionalnym:

Region 1

Katarzyna Pielńska

m. +48 606 294 713

email. katarzyna.pielinska@zinplast.pl

Region 2

Grzegorz Błaut

m. +48 608 516 500

email. grzegorz.blaut@zinplast.pl

Region 3

Mateusz Szewczyk

m. +48 668 015 129

email. mateusz.szewczyk@zinplast.pl

Region 4

Krzysztof Kwaśny

m. +48 538 240 999

email. krzysztof.kwasny@zinplast.pl

ZINPLAST Sp. z o.o.
ul. Garbarska 41, 32-340 Wolbrom

NIP: 637-011-19-47
REGON: 271 065 558
KRS: 000293317
BDO: 000045543

tel. +48 (32) 644 13 10
tel. +48 (32) 644 18 85
tel. +48 (32) 644 18 84
e-mail: kontakt@zinplast.pl

www.zinplast.pl