

CENNIK KSZTAŁTEK DO INSTALACJI WODNO-KANALIZACYJNYCH

edycja mar.22

data obowiązywania od: 01.04.2022

niniejszy cennik zastępuje wszystkie wydane przed 01.04.2022

podane ceny są cenami netto

30.03.2022

KSZTAŁTKI SEGMENTOWE DO WODY I KANALIZACJI CIŚNIENIOWEJ PE100, PE 100 RC

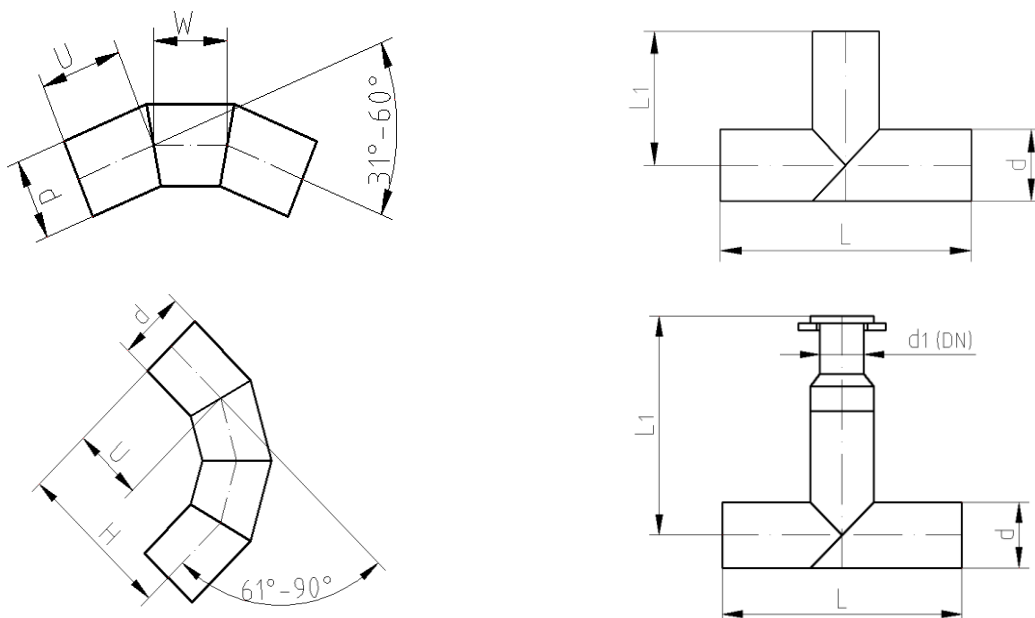

Specyfikacja techniczna

Budowa kształtki:	kształtki segmentowe jednowarstwowe i dwuwarstwowe
Przeznaczenie:	kształtki polietylenowe przeznaczone do wody i kanalizacji ciśnieniowej
Kolor:	Woda - czarny z niebieskimi paskami, Kanalizacja – czarny, czarny z brązowymi paskami Woda RC – kolor granatowy/czarny, czarny z niebieskimi paskami/czarny Kanalizacja RC - kolor czarny/ czarny, brązowy/czarny
Normy produktu:	PN EN 12201-3+A1
Materiał:	PE 100, PE 100 RC
Wymiary:	Ø90 do Ø 630 ; SDR 41 do SDR 7,4
Klasyfikacja statystyczna wyrobu:	PKWiU 25.21-21-53-10
Forma dostawy:	pakowane zbiorczo lub osobno w opakowania kartonowe lub foliowe
Dopuszczenia:	aktualne dokumenty odniesienia znajdują się na stronie www.zinplast.pl

Łuk segmentowy PE100 1-30st.

d	U [±10]	SDR11		SDR17	
		index	cena	index	cena
90	140	LS1130090	49,00	LS1730090	40,00
110	150	LS1130110	68,00	LS1730170	51,00
125	155	LS1130125	83,00	LS1730125	62,00
140	160	LS1130140	101,00	LS1730140	78,00
160	170	LS1130160	124,00	LS1730160	99,00
180	170	LS1130180	151,00	LS1730180	121,00
200	170	LS1130200	193,00	LS1730200	144,00
225	195	LS1130225	242,00	LS1730225	180,00
250	200	LS1130250	349,00	LS1730250	246,00
280	235	LS1130280	457,98	LS1730280	309,00
315	270	LS1130315	591,00	LS1730315	419,00
355	285	LS1130355	868,70	LS1730355	594,00
400	300	LS1130400	1 151,00	LS1730400	802,00
450	360	LS1130450	2 044,76	LS1730450	1 357,00
500	450	LS1130500	2 677,50	LS1730500	1 821,00
560	500	LS1130560	3 873,45	LS1730560	2 472,00
630	520	LS1130630	4 973,00	LS1730630	3 313,00

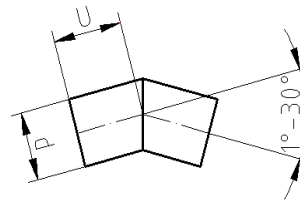

Łuk segmentowy PE100 31-60st.

d	[±10]U [±1]	[±10]W [±1]	SDR11		SDR17	
			index	cena	index	cena
90	140	120	LS1160090	89,00	LS1760090	69,00
110	150	120	LS1160110	106,00	LS1760110	90,00
125	155	140	LS1160125	133,00	LS1760125	111,00
140	160	145	LS1160140	162,00	LS1760140	137,00
160	170	150	LS1160160	203,00	LS1760160	172,00
180	170	155	LS1160180	266,00	LS1760180	213,00
200	170	170	LS1160200	318,00	LS1760200	257,00
225	195	180	LS1160225	391,00	LS1760225	302,00
250	200	185	LS1160250	534,00	LS1760250	389,00
280	235	205	LS1160280	693,77	LS1760280	482,00
315	270	230	LS1160315	882,00	LS1760315	607,00
355	285	265	LS1160355	1 194,76	LS1760355	870,00
400	300	295	LS1160400	1 620,00	LS1760400	1 246,00
450	370	350	LS1160450	2 651,66	LS1760450	2 000,00
500	470	400	LS1160500	3 873,45	LS1760500	2 736,00
560	520	450	LS1160560	5 372,85	LS1760560	3 737,00
630	540	510	LS1160630	7 247,10	LS1760630	4 973,00

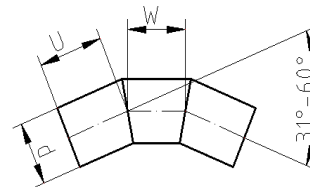

Łuk segmentowy PE100 61-90st.

d	[±10]U [±1]	[±10]H [±1]	SDR11		SDR17	
			index	cena	index	cena
90	140	300	LS1190090	128,00	LS1790090	103,00
110	150	310	LS1190110	150,00	LS1790110	128,00
125	155	340	LS1190125	193,00	LS1790125	162,00
140	160	355	LS1190140	227,00	LS1790140	187,00
160	170	370	LS1190160	278,00	LS1790160	237,00
180	170	380	LS1190180	377,00	LS1790180	303,79
200	170	400	LS1190200	441,00	LS1790200	361,00
225	195	440	LS1190225	539,00	LS1790225	439,45
250	200	450	LS1190250	715,00	LS1790250	549,00
280	235	515	LS1190280	715,00	LS1790280	667,76
315	270	580	LS1190315	1 182,00	LS1790315	821,00
355	285	645	LS1190355	1 528,98	LS1790355	1 150,22
400	300	700	LS1190400	2 070,60	LS1790400	1 646,62
450	360	800	LS1190450	3 445,05	LS1790450	2 451,00
500	450	950	LS1190500	4 783,80	LS1790500	3 388,00
560	500	1060	LS1190560	6 497,40	LS1790560	4 544,00
630	520	1170	LS1190630	8 585,85	LS1790630	6 208,00

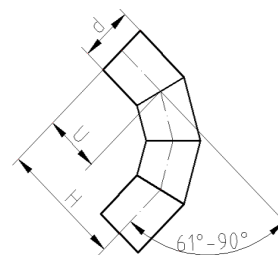

Trójnik segmentowy PE100 90st.

d	L[±10]	L1 [±10]	SDR11		SDR17	
			index	cena	index	cena
90	430	215	TS1190090	106,00	TS1790090	87,00
110	430	215	TS1190110	133,00	TS1790110	116,00
125	490	245	TS1190125	162,00	TS1790125	133,00
140	500	250	TS1190140	206,00	TS1790140	168,00
160	560	280	TS1190160	247,00	TS1790160	207,00
180	600	300	TS1190180	342,00	TS1790180	274,00
200	620	310	TS1190200	413,00	TS1790200	335,00
225	680	340	TS1190225	507,00	TS1790225	388,00
250	820	410	TS1190250	698,00	TS1790250	517,00
280	860	430	TS1190280	870,00	TS1790280	639,00
315	1000	500	TS1190315	1 231,00	TS1790315	946,73
355	1120	560	TS1190355	1 802,85	TS1790355	1 286,22
400	1200	600	TS1190400	2 496,45	TS1790400	1 835,00
450	1330	665	TS1190450	4 302,70	TS1790450	3 116,10
500	1480	740	TS1190500	8 121,75	TS1790500	4 402,00
560	1660	830	TS1190560	10 834,95	TS1790560	5 923,00
630	1730	865	TS1190630	13 512,45	TS1790630	8 139,00

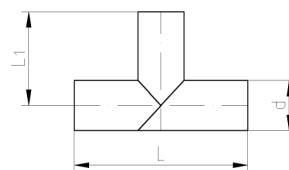

Trójnik segmentowy PE100 60st.

d	L[±10]	L1 [±10]	L2 [±10]	SDR11		SDR17	
				index	cena	index	cena
90	610	200	310	TS1160090	162,00	TS1760090	143,00
110	650	220	310	TS1160110	196,00	TS1760110	177,00
125	700	240	310	TS1160125	248,00	TS1760125	208,00
140	760	300	300	TS1160140	307,00	TS1760140	254,00
160	790	310	320	TS1160160	377,00	TS1760160	307,00
180	810	320	430	TS1160180	519,00	TS1760180	415,00
200	840	330	420	TS1160200	615,00	TS1760200	500,00
225	890	350	450	TS1160225	760,00	TS1760225	523,33
250	950	380	460	TS1160250	1 016,00	TS1760250	734,00

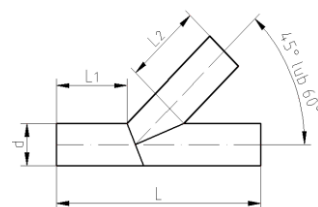

Trójnik segmentowy PE100 45st.

d	L[±10]	L1 [±10]	L2 [±10]	SDR11		SDR17	
				index	cena	index	cena
90	640	200	310	TS1145090	162,00	TS1745090	143,00
110	660	220	310	TS1145110	196,00	TS1745110	177,00
125	700	240	310	TS1145125	248,00	TS1745125	208,00
140	780	300	300	TS1145140	307,00	TS1745140	254,00
160	810	310	320	TS1145145	377,00	TS1745145	307,00
180	850	320	430	TS1145180	519,00	TS1745180	415,00
200	870	330	420	TS1145200	615,00	TS1745200	500,00

Trójnik segmentowy redukcyjny PE100 90st.

d/d1	L [±10]	L1 [±10]	SDR11		SDR17	
			index	cena	index	cena
90/63	430	325	TY1100001	181,00	TY1700001	175,00
90/75	430	325	TY1100002	181,00	TY1700002	175,00
110/63	430	335	TY1100003	222,00	TY1700003	206,00
110/75	430	335	TY1100004	222,00	TY1700004	206,00
110/90	430	330	TY1100005	222,00	TY1700005	206,00
125/63	490	350	TY1100006	270,00	TY1700006	237,00
125/75	490	350	TY1100007	270,00	TY1700007	237,00
125/90	490	350	TY1100008	270,00	TY1700008	240,00
125/110	490	350	TY1100009	270,00	TY1700009	240,00
140/63	500	360	TY1100010	359,00	TY1700010	260,10
140/90	500	360	TY1100011	359,00	TY1700011	261,80
140/110	500	360	TY1100012	359,00	TY1700012	263,50
140/125	500	360	TY1100013	359,00	TY1700013	265,20
160/63	560	390	TY1100014	414,00	TY1700014	266,90
160/75	560	390	TY1100015	414,00	TY1700015	268,60
160/90	560	400	TY1100016	414,00	TY1700016	270,30
160/110	560	400	TY1100017	414,00	TY1700017	272,00
160/125	560	400	TY1100018	414,00	TY1700018	273,70
160/140	560	400	TY1100019	414,00	TY1700019	275,40
180/63	600	510	TY1100020	680,00	TY1700020	277,10
180/75	600	510	TY1100021	680,00	TY1700021	278,80
180/90	600	520	TY1100022	578,00	TY1700022	280,50
180/110	600	520	TY1100023	578,00	TY1700023	282,20
180/125	600	520	TY1100024	578,00	TY1700024	283,90
180/140	600	520	TY1100025	578,00	TY1700025	285,60
180/160	600	410	TY1100026	578,00	TY1700026	287,30
200/63	620	550	TY1100027	814,30	TY1700027	289,00
200/75	620	550	TY1100028	814,30	TY1700028	290,70
200/90	620	560	TY1100029	702,10	TY1700029	292,40
200/110	620	560	TY1100030	702,10	TY1700030	294,10
200/125	620	560	TY1100031	702,10	TY1700031	295,80
200/140	620	560	TY1100032	702,10	TY1700032	297,50
200/160	620	440	TY1100033	702,10	TY1700033	299,20
200/180	620	400	TY1100034	702,10	TY1700034	300,90
225/63	680	585	TY1100035	989,40	TY1700035	302,60
225/75	680	585	TY1100036	989,40	TY1700036	304,30
225/90	680	585	TY1100037	918,00	TY1700037	306,00
225/110	680	585	TY1100038	918,00	TY1700038	307,70
225/125	680	585	TY1100039	918,00	TY1700039	309,40
225/140	680	585	TY1100040	918,00	TY1700040	311,10
225/160	680	470	TY1100041	918,00	TY1700041	312,80
225/180	680	430	TY1100042	870,00	TY1700042	314,50
225/200	680	430	TY1100043	870,00	TY1700043	316,20
250/63	820	650	TY1100044	1 217,20	TY1700044	317,90
250/75	820	650	TY1100045	1 217,20	TY1700045	319,60
250/90	820	660	TY1100046	1 113,50	TY1700046	321,30
250/110	820	660	TY1100047	1 113,50	TY1700047	323,00
250/125	820	660	TY1100048	1 113,50	TY1700048	324,70
250/140	820	660	TY1100049	1 113,50	TY1700049	326,40
250/160	820	540	TY1100050	1 113,50	TY1700050	328,10
250/180	820	600	TY1100051	1 113,50	TY1700051	329,80
250/200	820	505	TY1100052	1 072,70	TY1700052	331,50
250/225	820	505	TY1100053	1 072,70	TY1700053	333,20
280/63	860	770	TY1100054	1 504,50	TY1700054	334,90
280/75	860	770	TY1100055	1 504,50	TY1700055	336,60
280/90	860	780	TY1100056	1 504,50	TY1700056	338,30
280/110	860	780	TY1100057	1 504,50	TY1700057	340,00
280/125	860	780	TY1100058	1 504,50	TY1700058	341,70
280/140	860	780	TY1100059	1 504,50	TY1700059	343,40
280/160	860	660	TY1100060	1 361,70	TY1700060	345,10
280/180	860	620	TY1100061	1 361,70	TY1700061	346,80
280/200	860	620	TY1100062	1 361,70	TY1700062	348,50
280/225	860	525	TY1100063	1 361,70	TY1700063	350,20
280/250	860	500	TY1100064	1 361,70	TY1700064	351,90
315/63	1000	890	TY1100065	1 927,80	TY1700065	353,60
315/75	1000	890	TY1100066	1 927,80	TY1700066	355,30
315/90	1000	900	TY1100067	1 927,80	TY1700067	357,00
315/110	1000	900	TY1100068	1 927,80	TY1700068	358,70
315/125	1000	900	TY1100069	1 927,80	TY1700069	360,40
315/140	1000	900	TY1100070	1 927,80	TY1700070	362,10
315/160	1000	770	TY1100071	1 927,80	TY1700071	363,80
315/180	1000	740	TY1100072	1 927,80	TY1700072	365,50
315/200	1000	740	TY1100073	1 768,00	TY1700073	367,20
315/225	1000	650	TY1100074	1 768,00	TY1700074	368,90
315/250	1000	600	TY1100075	1 768,00	TY1700075	370,60
355/63	430	325	TY1100076	1 768,00	TY1700076	372,30
355/75	430	325	TY1100077	4 107,00	TY1700077	3 358,00
355/90	430	325	TY1100078	4 107,00	TY1700078	3 358,00
355/110	430	335	TY1100079	2 624,80	TY1700079	2 267,80
355/125	430	335	TY1100080	2 624,80	TY1700080	2 269,50
355/140	430	330	TY1100081	2 624,80	TY1700081	2 271,20
355/160	490	350	TY1100082	2 624,80	TY1700082	2 272,90
355/180	490	350	TY1100083	2 624,80	TY1700083	2 274,60
355/200	490	350	TY1100084	2 624,80	TY1700084	2 267,80
355/225	500	360	TY1100085	2 391,90	TY1700085	1 980,50
355/250	500	360	TY1100086	2 391,90	TY1700086	1 980,50
355/280	500	360	TY1100087	2 391,90	TY1700087	1 980,50
355/315	560	390	TY1100088	2 391,90	TY1700088	1 980,50
355/315	560	390	TY1100089	2 391,90	TY1700089	1 980,50

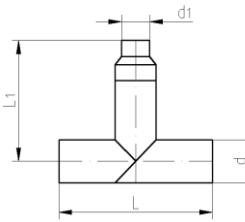

400/63	560	400	TY1100090	5 510,00	TY1700090	4 602,00
400/75	560	400	TY1100091	5 510,00	TY1700091	4 602,00
400/90	560	400	TY1100092	4 017,10	TY1700092	3 408,50
400/110	560	400	TY1100093	4 017,10	TY1700093	3 408,50
400/125	600	510	TY1100094	4 017,10	TY1700094	3 408,50
400/140	600	510	TY1100095	4 017,10	TY1700095	3 408,50
400/160	600	520	TY1100096	4 017,10	TY1700096	3 408,50
400/180	600	520	TY1100097	4 017,10	TY1700097	3 408,50
400/200	600	520	TY1100098	3 605,70	TY1700098	2 998,80
400/225	600	410	TY1100099	3 605,70	TY1700099	2 998,80
400/250	620	550	TY1100100	3 605,70	TY1700100	2 998,80
400/280	620	560	TY1100101	3 605,70	TY1700101	2 998,80
400/315	620	560	TY1100102	3 605,70	TY1700102	2 998,80
400/355	620	440	TY1100103	3 605,70	TY1700103	2 998,80
450/63	620	400	TY1100104	6 908,71	TY1700104	5 902,22
450/75	620	400	TY1100105	6 908,71	TY1700105	5 902,22
450/90	680	585	TY1100106	6 904,98	TY1700106	5 877,47
450/110	680	585	TY1100107	6 904,98	TY1700107	5 877,47
450/125	680	585	TY1100108	6 904,98	TY1700108	5 877,47
450/140	680	585	TY1100109	6 904,98	TY1700109	5 877,47
450/160	680	585	TY1100110	6 776,95	TY1700110	5 745,60
450/180	680	470	TY1100111	6 705,53	TY1700111	5 662,20
450/200	680	470	TY1100112	6 705,53	TY1700112	5 662,20
450/225	680	430	TY1100113	6 404,50	TY1700113	5 302,64
450/250	820	650	TY1100114	6 404,50	TY1700114	5 302,64
450/280	820	660	TY1100115	6 404,50	TY1700115	5 302,64
450/315	820	660	TY1100116	5 900,18	TY1700116	4 703,06
450/355	820	540	TY1100117	5 813,74	TY1700117	5 061,04
450/400	820	600	TY1100118	5 753,51	TY1700118	4 989,40
500/63	820	505	TY1100119	12 955,68	TY1700119	10 484,48
500/75	820	505	TY1100120	12 955,68	TY1700120	10 484,48
500/90	860	770	TY1100121	12 951,95	TY1700121	10 479,96
500/110	860	770	TY1100122	12 951,95	TY1700122	10 479,96
500/125	860	780	TY1100123	12 951,95	TY1700123	10 479,96
500/140	860	780	TY1100124	12 951,95	TY1700124	10 479,96
500/160	860	780	TY1100125	12 823,92	TY1700125	10 327,86
500/180	860	660	TY1100126	12 752,50	TY1700126	10 242,77
500/200	860	660	TY1100127	12 481,53	TY1700127	10 242,77
500/225	860	620	TY1100128	12 481,53	TY1700128	9 920,61
500/250	860	525	TY1100129	12 481,53	TY1700129	9 920,61
500/280	860	500	TY1100130	12 481,53	TY1700130	9 920,61
500/315	1000	890	TY1100131	11 947,26	TY1700131	9 285,21
500/355	1000	900	TY1100132	11 860,71	TY1700132	9 182,27
500/400	1000	900	TY1100133	11 800,48	TY1700133	9 110,74
500/450	1000	770	TY1100134	10 201,19	TY1700134	7 208,95
560/63	1000	740	TY1100135	15 269,80	TY1700135	12 225,13
560/75	1000	740	TY1100136	15 269,80	TY1700136	12 225,13
560/90	1000	650	TY1100137	15 266,07	TY1700137	12 220,72
560/110	1000	650	TY1100138	15 266,07	TY1700138	12 220,72
560/125	1000	600	TY1100139	15 266,07	TY1700139	12 220,72
560/140	1000	600	TY1100140	15 266,07	TY1700140	12 220,72
560/160	1000	550	TY1100141	15 138,16	TY1700141	12 068,51
560/180	1660	1370	TY1100142	15 066,63	TY1700142	11 983,54
560/200	1660	1370	TY1100143	15 066,63	TY1700143	11 983,54
560/225	1660	1280	TY1100144	14 795,77	TY1700144	11 661,37
560/250	1660	1230	TY1100145	14 795,77	TY1700145	11 661,37
560/280	1660	1180	TY1100146	14 795,77	TY1700146	11 661,37
560/315	1660	1120	TY1100147	14 795,77	TY1700147	11 151,18
560/355	1660	1070	TY1100148	14 174,83	TY1700148	10 923,03
560/400	1660	1010	TY1100149	14 114,60	TY1700149	10 851,39
560/450	1660	940	TY1100150	12 515,43	TY1700150	8 949,60
560/500	1660	885	TY1100151	12 786,29	TY1700151	9 441,83
630/63	1730	1600	TY1100152	19 424,14	TY1700152	14 932,39
630/75	1730	1600	TY1100153	19 424,14	TY1700153	14 932,39
630/90	1730	1610	TY1100154	19 420,29	TY1700154	14 927,98
630/110	1730	1610	TY1100155	19 420,29	TY1700155	14 927,98
630/125	1730	1610	TY1100156	19 420,29	TY1700156	14 927,98
630/140	1730	1610	TY1100157	19 420,29	TY1700157	14 927,98
630/160	1730	1490	TY1100158	19 290,46	TY1700158	14 775,77
630/180	1730	1450	TY1100159	19 220,85	TY1700159	14 690,79
630/200	1730	1450	TY1100160	18 949,99	TY1700160	14 690,79
630/225	1730	1360	TY1100161	18 949,99	TY1700161	14 368,63
630/250	1730	1310	TY1100162	18 949,99	TY1700162	14 368,63
630/280	1730	1260	TY1100163	18 949,99	TY1700163	14 368,63
630/315	1730	1200	TY1100164	18 415,61	TY1700164	13 733,12
630/355	1730	1150	TY1100165	18 329,05	TY1700165	11 596,29
630/400	1730	1090	TY1100166	18 268,94	TY1700166	13 558,64
630/450	1730	1020	TY1100167	16 669,65	TY1700167	11 656,85
630/500	1730	970	TY1100168	16 455,17	TY1700168	12 158,01
630/560	1730	920	TY1100169	16 327,26	TY1700169	12 005,91

Trójnik segmentowy redukcyjny PE100 60st.

d/d1	L[±10]	L1 [±10]	L2 [±10]	L3 [±10]	SDR11		SDR17	
					index	cena	index	cena
90/63	610	200	310	230	TY1100170	206,00	TY1700170	182,00
90/75	610	200	310	230	TY1100171	206,00	TY1700171	182,00
110/63	650	220	310	230	TY1100172	296,00	TY1700172	276,00
110/75	650	220	310	230	TY1100173	296,00	TY1700173	276,00
110/90	650	220	320	230	TY1100174	296,00	TY1700174	276,00
125/63	700	240	310	230	TY1100175	359,00	TY1700175	314,00
125/75	700	240	310	230	TY1100176	359,00	TY1700176	314,00
125/90	700	240	310	230	TY1100177	359,00	TY1700177	314,00
125/110	700	240	310	230	TY1100178	359,00	TY1700178	314,00
140/63	760	300	300	230	TY1100179	522,00	TY1700179	496,00
140/90	760	300	300	230	TY1100180	522,00	TY1700180	496,00
140/110	760	300	300	230	TY1100181	522,00	TY1700181	496,00
140/125	760	300	300	230	TY1100182	522,00	TY1700182	496,00
160/63	790	310	320	230	TY1100183	562,00	TY1700183	475,00
160/75	790	310	320	230	TY1100184	562,00	TY1700184	475,00
160/90	790	310	320	230	TY1100185	562,00	TY1700185	475,00
160/110	790	310	330	230	TY1100186	562,00	TY1700186	475,00
160/125	790	310	320	230	TY1100187	562,00	TY1700187	475,00
160/140	790	310	320	230	TY1100188	562,00	TY1700188	475,00
180/63	810	320	430	230	TY1100189	789,00	TY1700189	719,00
180/75	810	320	430	230	TY1100190	789,00	TY1700190	719,00
180/90	810	320	440	230	TY1100191	789,00	TY1700191	715,00
180/110	810	320	440	230	TY1100192	789,00	TY1700192	715,00
180/125	810	320	430	230	TY1100193	789,00	TY1700193	715,00
180/140	810	320	430	230	TY1100194	789,00	TY1700194	715,00
180/160	810	320	420	230	TY1100195	789,00	TY1700195	637,00
200/63	840	330	420	230	TY1100196	1 158,00	TY1700196	1 032,00
200/75	840	330	420	230	TY1100197	1 158,00	TY1700197	1 032,00
200/90	840	330	430	230	TY1100198	1 158,00	TY1700198	1 011,00
200/110	840	330	430	230	TY1100199	1 143,00	TY1700199	1 011,00
200/125	840	330	420	230	TY1100200	1 143,00	TY1700200	1 032,00
200/140	840	330	420	230	TY1100201	1 143,00	TY1700201	1 032,00
200/160	840	330	350	230	TY1100202	1 075,00	TY1700202	882,00
200/180	840	330	300	230	TY1100203	1 075,00	TY1700203	853,00
225/63	890	350	450	230	TY1100204	1 449,00	TY1700204	1 139,00
225/75	890	350	450	230	TY1100205	1 449,00	TY1700205	1 139,00
225/90	890	350	470	230	TY1100206	1 443,00	TY1700206	1 122,00
225/110	890	350	470	230	TY1100207	1 443,00	TY1700207	1 122,00
225/125	890	350	450	230	TY1100208	1 443,00	TY1700208	1 122,00
225/140	890	350	450	230	TY1100209	1 443,00	TY1700209	1 122,00
225/160	890	350	350	230	TY1100210	1 365,00	TY1700210	1 041,00
225/180	890	350	320	230	TY1100211	1 365,00	TY1700211	996,00
225/200	890	350	320	230	TY1100212	1 433,00	TY1700212	996,00
250/63	950	380	460	230	TY1100213	1 683,00	TY1700213	1 385,00
250/75	950	380	460	230	TY1100214	1 683,00	TY1700214	1 385,00
250/90	950	380	480	230	TY1100215	1 673,00	TY1700215	1 365,00
250/110	950	380	480	230	TY1100216	1 673,00	TY1700216	1 365,00
250/125	950	380	460	230	TY1100217	1 683,00	TY1700217	1 399,00
250/140	950	380	460	230	TY1100218	1 683,00	TY1700218	1 399,00
250/160	950	380	350	230	TY1100219	1 528,00	TY1700219	1 253,00
250/180	950	380	420	230	TY1100220	1 528,00	TY1700220	1 362,00
250/200	950	380	320	230	TY1100221	1 515,00	TY1700221	1 197,00
250/225	950	380	320	230	TY1100222	1 381,00	TY1700222	1 197,00

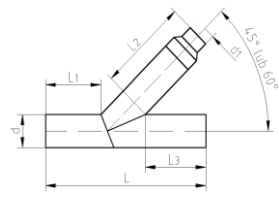

Trójnik segmentowy redukcyjny PE100 45st.

d/d1	L[±10]	L1 [±10]	L2 [±10]	L3 [±10]	SDR11		SDR17	
					index	cena	index	cena
90/63	640	200	310	230	TY1100223	206,00	TY1700223	182,00
90/75	640	200	310	230	TY1100224	206,00	TY1700224	182,00
110/63	660	220	310	230	TY1100225	296,00	TY1700225	276,00
110/75	660	220	310	230	TY1100226	296,00	TY1700226	276,00
110/90	660	220	320	230	TY1100227	296,00	TY1700227	276,00
125/63	700	240	310	230	TY1100228	359,00	TY1700228	314,00
125/75	700	240	310	230	TY1100229	359,00	TY1700229	314,00
125/90	700	240	310	230	TY1100230	359,00	TY1700230	314,00
125/110	700	240	310	230	TY1100231	359,00	TY1700231	314,00
140/63	780	300	300	230	TY1100232	522,00	TY1700232	496,00
140/90	780	300	300	230	TY1100233	522,00	TY1700233	496,00
140/110	780	300	300	230	TY1100234	522,00	TY1700234	496,00
140/125	780	300	300	230	TY1100235	522,00	TY1700235	496,00
160/63	810	310	320	230	TY1100236	562,00	TY1700236	475,00
160/75	810	310	320	230	TY1100237	562,00	TY1700237	475,00
160/90	810	310	320	230	TY1100238	562,00	TY1700238	475,00
160/110	810	310	330	230	TY1100239	562,00	TY1700239	475,00
160/125	810	310	320	230	TY1100240	562,00	TY1700240	475,00
160/140	810	310	320	230	TY1100241	562,00	TY1700241	475,00
180/63	850	320	430	230	TY1100242	789,00	TY1700242	719,00
180/75	850	320	430	230	TY1100243	789,00	TY1700243	719,00
180/90	850	320	440	230	TY1100244	789,00	TY1700244	715,00
180/110	850	320	440	230	TY1100245	789,00	TY1700245	715,00
180/125	850	320	430	230	TY1100246	789,00	TY1700246	715,00
180/140	850	320	430	230	TY1100247	789,00	TY1700247	715,00
180/160	850	320	420	230	TY1100248	789,00	TY1700248	637,00
200/63	870	330	420	230	TY1100249	1 158,00	TY1700249	1 032,00
200/75	870	330	420	230	TY1100250	1 158,00	TY1700250	1 032,00
200/90	870	330	430	230	TY1100251	1 158,00	TY1700251	1 011,00
200/110	870	330	430	230	TY1100252	1 143,00	TY1700252	1 011,00
200/125	870	330	420	230	TY1100253	1 143,00	TY1700253	1 032,00
200/140	870	330	420	230	TY1100254	1 143,00	TY1700254	1 032,00
200/160	870	330	350	230	TY1100255	1 075,00	TY1700255	882,00
200/180	870	330	300	230	TY1100256	1 075,00	TY1700256	853,00

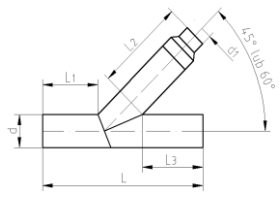

Trójnik segmentowy PE100 kołnierzowy 90st.

d	d1DNd1DN	-[±10]L[±10]	[±10]L1 [±	SDR11		SDR17	
				index	cena	index	cena
90	90/80	430	340	TK1100090	254,00	TK1700090	243,84
110	110/100	430	340	TK1100110	326,00	TK1700110	305,54
125	125/100	490	380	TK1100125	398,72	TK1700125	341,50
140	140/125	500	360	TK1100140	468,86	TK1700140	418,56
160	160/150	560	425	TK1100160	580,22	TK1700160	554,11
180	180/150	600	445	TK1100180	726,66	TK1700180	670,98
200	200/200	620	445	TK1100200	896,51	TK1700200	812,67
225	225/200	680	485	TK1100225	1 080,32	TK1700225	887,04
250	250/250	820	550	TK1100250	1 521,66	TK1700250	1 315,07
280	280/250	860	570	TK1100280	1 814,40	TK1700280	1 520,90
315	315/300	1000	640	TK1100315	2 308,10	TK1700315	1 959,30
355	355/350	1120	670	TK1100355	3 442,56	TK1700355	2 949,76
400	400/400	1200	720	TK1100400	4 934,27	TK1700400	4 146,30
450	450/500	1330	785	TK1100450	8 425,47	TK1700450	6 538,75
500	500/500	1480	860	TK1100500	11 996,16	TK1700500	8 525,95
560	560/600	1660	940	TK1100560	16 651,01	TK1700560	11 474,94
630	630/600	1730	970	TK1100630	20 697,60	TK1700630	14 308,99

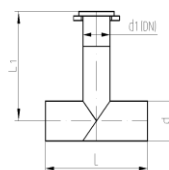

Trójnik segmentowy redukcyjny PE100 kołnierzowy 90st.

d/d1	10]L[±10]L[-10]L1 [±10]L	index	SDR11		SDR17	
			index	cena	index	cena
90/63	430	435	TU1100001	224,60	TU1700001	215,70
90/75	430	445	TU1100002	224,60	TU1700002	215,70
110/63	430	445	TU1100003	247,60	TU1700003	238,70
110/75	430	440	TU1100004	247,60	TU1700004	246,50
110/90	430	455	TU1100005	279,70	TU1700005	269,30
125/63	490	455	TU1100006	284,60	TU1700006	267,80
125/75	490	460	TU1100007	284,60	TU1700007	280,00
125/90	490	475	TU1100008	318,80	TU1700008	310,10
125/110	490	475	TU1100009	330,00	TU1700009	306,40
140/63	500	465	TU1100010	314,20	TU1700010	272,80
140/90	500	485	TU1100011	328,30	TU1700011	302,70
140/110	500	485	TU1100012	342,00	TU1700012	327,30
140/125	500	495	TU1100013	354,50	TU1700013	331,20
160/63	560	490	TU1100014	421,30	TU1700014	399,60
160/75	560	495	TU1100015	421,30	TU1700015	401,30
160/90	560	525	TU1100016	433,40	TU1700016	408,90
160/110	560	525	TU1100017	453,00	TU1700017	431,50
160/125	560	535	TU1100018	509,60	TU1700018	497,60
160/140	560	510	TU1100019	552,60	TU1700019	494,70
180/63	600	495	TU1100020	589,80	TU1700020	570,70
180/75	600	500	TU1100021	589,80	TU1700021	570,70
180/90	600	645	TU1100022	565,40	TU1700022	542,60
180/110	600	645	TU1100023	583,70	TU1700023	560,90
180/125	600	655	TU1100024	584,60	TU1700024	578,80
180/140	600	630	TU1100025	711,00	TU1700025	630,70
180/160	600	550	TU1100026	630,60	TU1700026	527,80
200/63	620	655	TU1100027	812,40	TU1700027	720,60
200/75	620	660	TU1100028	812,40	TU1700028	720,60
200/90	620	680	TU1100029	728,10	TU1700029	699,20
200/110	620	680	TU1100030	751,20	TU1700030	717,60
200/125	620	690	TU1100031	750,00	TU1700031	740,50
200/140	620	665	TU1100032	800,00	TU1700032	822,80
200/160	620	580	TU1100033	808,60	TU1700033	769,10
200/180	620	540	TU1100034	843,20	TU1700034	853,40
225/63	680	690	TU1100035	933,20	TU1700035	864,90
225/75	680	695	TU1100036	933,20	TU1700036	864,90
225/90	680	715	TU1100037	924,10	TU1700037	864,90
225/110	680	715	TU1100038	959,50	TU1700038	889,70
225/125	680	700	TU1100039	954,60	TU1700039	902,10
225/140	680	700	TU1100040	960,80	TU1700040	989,40
225/160	680	615	TU1100041	1 264,80	TU1700041	897,80
225/180	680	570	TU1100042	1 278,00	TU1700042	1 031,90
225/200	680	560	TU1100043	878,00	TU1700043	716,30
250/63	820	655	TU1100044	1 109,20	TU1700044	1 054,00
250/75	820	660	TU1100045	1 109,20	TU1700045	1 054,00
250/90	820	675	TU1100046	1 103,60	TU1700046	1 058,70
250/110	820	675	TU1100047	1 116,00	TU1700047	1 064,90
250/125	820	685	TU1100048	1 115,00	TU1700048	1 076,40
250/140	820	660	TU1100049	1 230,80	TU1700049	1 173,00
250/160	820	680	TU1100050	1 138,80	TU1700050	1 047,80
250/180	820	740	TU1100051	1 241,00	TU1700051	1 149,20
250/200	820	635	TU1100052	1 137,60	TU1700052	1 107,20
250/225	820	645	TU1100053	1 296,00	TU1700053	1 133,90
280/63	860	875	TU1100054	1 414,90	TU1700054	1 287,40
280/75	860	880	TU1100055	1 414,90	TU1700055	1 303,80
280/90	860	905	TU1100056	1 424,30	TU1700056	1 321,60
280/110	860	905	TU1100057	1 424,30	TU1700057	1 340,80
280/125	860	915	TU1100058	1 424,30	TU1700058	1 391,10
280/140	860	890	TU1100059	1 564,00	TU1700059	1 436,50
280/160	860	800	TU1100060	1 402,80	TU1700060	1 329,10
280/180	860	760	TU1100061	1 538,50	TU1700061	1 448,40
280/200	860	750	TU1100062	1 519,00	TU1700062	1 309,00
280/225	860	625	TU1100063	1 666,00	TU1700063	1 411,00
280/250	860	640	TU1100064	1 503,50	TU1700064	1 161,60

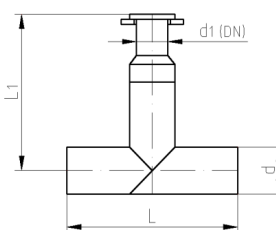

315/63	1000	995	TU1100065	1 770,10	TU1700065	1 587,20
315/75	1000	1000	TU1100066	1 770,10	TU1700066	1 628,20
315/90	1000	1015	TU1100067	1 796,50	TU1700067	1 598,10
315/110	1000	1015	TU1100068	1 826,80	TU1700068	1 615,10
315/125	1000	1020	TU1100069	1 826,80	TU1700069	1 625,50
315/140	1000	1010	TU1100070	2 002,60	TU1700070	1 783,30
315/160	1000	910	TU1100071	1 832,10	TU1700071	1 539,20
315/180	1000	880	TU1100072	2 009,40	TU1700072	1 688,10
315/200	1000	870	TU1100073	1 828,20	TU1700073	1 615,30
315/225	1000	790	TU1100074	1 883,60	TU1700074	1 684,70
315/250	1000	740	TU1100075	1 840,80	TU1700075	1 683,30
315/280	1000	690	TU1100076	2 006,00	TU1700076	1 846,20
355/63	1120	1115	TU1100077	3 582,90	TU1700077	3 040,60
355/75	1120	1120	TU1100078	3 609,10	TU1700078	3 066,80
355/90	1120	1140	TU1100079	3 620,30	TU1700079	3 078,00
355/110	1120	1140	TU1100080	3 296,50	TU1700080	2 805,30
355/125	1120	1150	TU1100081	3 291,90	TU1700081	2 840,50
355/140	1120	1125	TU1100082	3 680,20	TU1700082	3 137,90
355/160	1120	1050	TU1100083	3 261,70	TU1700083	2 828,00
355/180	1120	1020	TU1100084	3 601,60	TU1700084	3 059,30
355/200	1120	1010	TU1100085	3 124,00	TU1700085	2 623,80
355/225	1120	920	TU1100086	3 463,20	TU1700086	2 868,60
355/250	1120	880	TU1100087	3 296,50	TU1700087	2 755,30
355/280	1120	840	TU1100088	3 680,20	TU1700088	3 070,50
355/315	1120	750	TU1100089	2 823,30	TU1700089	2 448,40
400/63	1120	1205	TU1100090	4 336,60	TU1700090	3 737,40
400/75	1120	1210	TU1100091	4 360,40	TU1700091	3 761,20
400/90	1120	1235	TU1100092	4 370,50	TU1700092	3 771,50
400/110	1200	1235	TU1100093	4 387,50	TU1700093	3 788,50
400/125	1200	1245	TU1100094	4 404,40	TU1700094	3 830,10
400/140	1200	1220	TU1100095	4 884,40	TU1700095	4 196,30
400/160	1200	1140	TU1100096	4 373,90	TU1700096	3 774,90
400/180	1200	1100	TU1100097	4 805,90	TU1700097	4 117,70
400/200	1200	1090	TU1100098	4 252,70	TU1700098	3 637,00
400/225	1200	1010	TU1100099	4 667,50	TU1700099	3 927,00
400/250	1200	960	TU1100100	4 387,50	TU1700100	3 744,30
400/280	1200	910	TU1100101	4 833,40	TU1700101	4 129,00
400/315	1200	815	TU1100102	4 069,00	TU1700102	3 413,40
400/355	1200	770	TU1100103	4 624,90	TU1700103	3 911,30
450/63	1330	1325	TU1100104	6 459,00	TU1700104	5 753,40
450/75	1330	1335	TU1100105	6 461,80	TU1700105	5 756,50
450/90	1330	1350	TU1100106	6 477,50	TU1700106	5 773,90
450/110	1330	1350	TU1100107	6 486,90	TU1700107	5 784,40
450/125	1330	1360	TU1100108	6 493,10	TU1700108	5 791,40
450/140	1330	1340	TU1100109	6 512,20	TU1700109	5 826,90
450/160	1330	1260	TU1100110	6 485,60	TU1700110	5 783,00
450/180	1330	1230	TU1100111	6 432,40	TU1700111	5 723,80
450/200	1330	1220	TU1100112	6 435,90	TU1700112	5 676,70
450/225	1330	1130	TU1100113	6 273,20	TU1700113	5 495,50
450/250	1330	1080	TU1100114	6 323,30	TU1700114	5 535,60
450/280	1330	1030	TU1100115	6 342,00	TU1700115	5 556,50
450/315	1330	970	TU1100116	6 008,30	TU1700116	5 128,90
450/355	1330	900	TU1100117	6 199,70	TU1700117	5 231,00
450/400	1330	845	TU1100118	6 389,20	TU1700118	5 405,30
500/63	1480	1460	TU1100119	11 113,50	TU1700119	7 732,90
500/75	1480	1470	TU1100120	11 116,30	TU1700120	9 178,80
500/90	1480	1490	TU1100121	11 131,90	TU1700121	9 196,20
500/110	1480	1490	TU1100122	11 141,30	TU1700122	9 206,70
500/125	1480	1500	TU1100123	11 147,60	TU1700123	9 213,70
500/140	1480	1475	TU1100124	11 166,70	TU1700124	9 249,20
500/160	1480	1395	TU1100125	11 090,00	TU1700125	9 149,50
500/180	1480	1370	TU1100126	11 036,80	TU1700126	9 090,30
500/200	1480	1360	TU1100127	11 115,30	TU1700127	9 126,90
500/225	1480	1270	TU1100128	10 890,10	TU1700128	8 876,00
500/250	1480	1220	TU1100129	11 002,70	TU1700129	8 985,70
500/280	1480	1170	TU1100130	11 021,50	TU1700130	9 006,60
500/315	1480	1110	TU1100131	10 719,00	TU1700131	8 613,90
500/355	1480	1035	TU1100132	10 910,50	TU1700132	8 716,00
500/400	1480	980	TU1100133	11 068,70	TU1700133	8 855,40
500/450	1480	930	TU1100134	10 291,10	TU1700134	7 945,80

560/63	1660	1620	TU1100135	15 158,00	TU1700135	10 940,60
560/75	1660	1630	TU1100136	15 160,80	TU1700136	10 943,30
560/90	1660	1650	TU1100137	15 176,40	TU1700137	10 553,70
560/110	1660	1650	TU1100138	15 185,80	TU1700138	10 967,90
560/125	1660	1660	TU1100139	15 192,10	TU1700139	10 974,10
560/140	1660	1635	TU1100140	15 211,20	TU1700140	11 005,40
560/160	1660	1550	TU1100141	15 134,50	TU1700141	10 917,50
560/180	1660	1510	TU1100142	15 087,60	TU1700142	10 871,40
560/200	1660	1500	TU1100143	15 166,10	TU1700143	10 903,70
560/225	1660	1420	TU1100144	14 934,60	TU1700144	10 676,10
560/250	1660	1370	TU1100145	15 047,20	TU1700145	10 773,00
560/280	1660	1320	TU1100146	15 066,00	TU1700146	10 791,40
560/315	1660	1260	TU1100147	14 757,30	TU1700147	10 438,70
560/355	1660	1180	TU1100148	14 923,70	TU1700148	10 504,20
560/400	1660	1130	TU1100149	15 113,20	TU1700149	10 658,00
560/450	1660	1060	TU1100150	13 206,40	TU1700150	8 511,60
560/500	1660	1010	TU1100151	13 372,20	TU1700151	8 763,80
630/63	1730	1705	TU1100152	20 319,20	TU1700152	14 882,70
630/75	1730	1715	TU1100153	20 322,00	TU1700153	14 885,50
630/90	1730	1735	TU1100154	20 337,60	TU1700154	14 900,90
630/110	1730	1735	TU1100155	20 347,00	TU1700155	14 910,10
630/125	1730	1745	TU1100156	20 353,30	TU1700156	14 916,20
630/140	1730	1720	TU1100157	20 372,40	TU1700157	14 947,60
630/160	1730	1630	TU1100158	20 295,70	TU1700158	14 859,60
630/180	1730	1590	TU1100159	20 242,50	TU1700159	14 807,40
630/200	1730	1580	TU1100160	20 321,10	TU1700160	14 839,70
630/225	1730	1500	TU1100161	20 095,80	TU1700161	14 618,30
630/250	1730	1450	TU1100162	20 208,40	TU1700162	14 715,10
630/280	1730	1400	TU1100163	20 214,70	TU1700163	14 721,30
630/315	1730	1340	TU1100164	19 893,50	TU1700164	14 356,30
630/355	1730	1260	TU1100165	20 084,90	TU1700165	14 446,40
630/400	1730	1230	TU1100166	20 274,40	TU1700166	14 660,00
630/450	1730	1160	TU1100167	16 847,40	TU1700167	10 959,30
630/500	1730	1110	TU1100168	16 609,70	TU1700168	10 814,80
630/560	1730	1030	TU1100169	17 457,40	TU1700169	11 279,10

Czwórnik segmentowy PE100

d	L[±10]	L1 [±10]	SDR11		SDR17	
			index	cena	index	cena
110	920	460	CZ1100001	288,34	CZ1700001	261,84
125	1040	520	CZ1100002	338,47	CZ1700002	318,10
140	1060	530	CZ1100003	448,46	CZ1700003	361,39
160	1180	590	CZ1100004	520,99	CZ1700004	469,75
180	1260	630	CZ1100005	649,66	CZ1700005	581,93
200	1300	650	CZ1100006	801,94	CZ1700006	734,21
225	1430	715	CZ1100007	960,12	CZ1700007	892,37
250	1710	855	CZ1100008	1 263,12	CZ1700008	1 217,98
280	1810	905	CZ1100009	1 733,35	CZ1700009	1 559,18
315	2120	1060	CZ1100010	2 293,58	CZ1700010	2 119,39

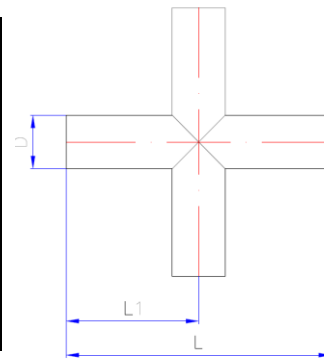

Uskok segmentowy PE100 równoprzelotowy 45st.

d	L [±10]	L1 [±10]	H [±10]	SDR11		SDR17	
				index	cena	index	cena
90	650	180	300	US1100090	126,00	US1700090	102,00
110	670	190	300	US1100110	139,00	US1700110	131,00
125	690	190	300	US1100125	182,00	US1700125	159,00
140	700	200	300	US1100140	221,00	US1700140	188,00
160	730	220	300	US1100160	252,00	US1700160	223,00
180	750	230	300	US1100180	348,00	US1700180	306,00
200	810	250	300	US1100200	435,00	US1700200	387,00
225	820	260	300	US1100225	524,00	US1700225	453,00
250	880	290	300	US1100250	707,00	US1700250	592,00
280	920	310	300	US1100280	887,00	US1700280	751,00
315	1000	350	300	US1100315	1 152,00	US1700315	909,00

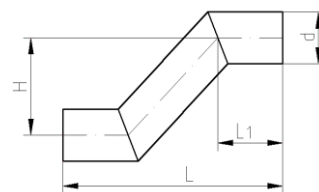

Tuleja kolnierzowa PE100 z króćcem

d	L [±10]	L1 [±10]	SDR11		SDR17	
			index	cena	index	cena
250	350	200	YA110250	297,94	YA170250	279,79
280	400	250	YA110280	353,81	YA170280	325,15
315	400	250	YA110315	417,31	YA170315	381,02
355	405	280	YA110355	638,06	YA170355	632,02
400	405	280	YA110400	1 063,30	YA170400	970,70
450	415	280	YA110450	1 346,40	YA170450	1 149,98
500	450	300	YA110500	1 717,06	YA170500	1 473,12
560	450	300	YA110560	2 106,72	YA170560	1 821,60
630	450	300	YA110630	2 543,90	YA170630	2 179,58

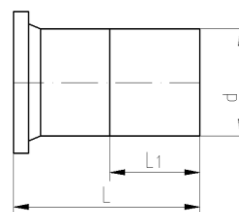

Trójnik siodłowy PE100 redukcyjny 90st.

d/d1	[±10]L	[±10]L1	[±10]L2	SDR11		SDR17	
				index	cena	index	cena
200/63	660	260	65	ST1100001	668,10	ST1700001	614,65
200/75	660	260	70	ST1100002	668,10	ST1700002	614,65
200/90	660	260	80	ST1100003	884,00	ST1700003	813,28
200/110	660	260	90	ST1100004	884,00	ST1700004	813,28
200/125	660	260	100	ST1100005	884,00	ST1700005	813,28
225/63	710	270	65	ST1100006	741,20	ST1700006	681,90
225/75	710	270	70	ST1100007	741,20	ST1700007	681,90
225/90	710	270	80	ST1100008	955,40	ST1700008	878,97
225/110	710	270	90	ST1100009	955,40	ST1700009	878,97
225/125	710	270	100	ST1100010	955,40	ST1700010	878,97
250/63	850	285	65	ST1100011	892,50	ST1700011	821,10
250/75	850	285	70	ST1100012	892,50	ST1700012	821,10
250/90	850	285	80	ST1100013	1 106,70	ST1700013	1 018,16
250/110	850	285	90	ST1100014	1 106,70	ST1700014	1 018,16
250/125	850	285	100	ST1100015	1 106,70	ST1700015	1 018,16
250/140	850	285	90	ST1100016	1 232,50	ST1700016	1 133,90
250/160	850	285	95	ST1100017	1 232,50	ST1700017	1 133,90
280/63	890	300	65	ST1100018	1 008,10	ST1700018	927,45
280/75	890	300	70	ST1100019	1 008,10	ST1700019	927,45
280/90	890	300	80	ST1100020	1 224,00	ST1700020	1 126,08
280/110	890	300	90	ST1100021	1 224,00	ST1700021	1 126,08
280/125	890	300	100	ST1100022	1 224,00	ST1700022	1 126,08
280/140	890	300	90	ST1100023	1 349,80	ST1700023	1 241,82
280/160	890	300	95	ST1100024	1 349,80	ST1700024	1 241,82
315/63	1030	320	65	ST1100025	1 042,10	ST1700025	958,73
315/75	1030	320	70	ST1100026	1 042,10	ST1700026	958,73
315/90	1030	320	80	ST1100027	1 258,00	ST1700027	1 157,36
315/110	1030	320	90	ST1100028	1 258,00	ST1700028	1 157,36
315/125	1030	320	100	ST1100029	1 258,00	ST1700029	1 157,36
315/140	1030	310	90	ST1100030	1 524,90	ST1700030	1 402,91
315/160	1030	310	95	ST1100031	1 524,90	ST1700031	1 402,91
315/180	1030	310	100	ST1100032	1 671,10	ST1700032	1 537,41
315/200	1030	310	110	ST1100033	1 961,80	ST1700033	1 804,86
355/63	1150	335	65	ST1100034	1 275,00	ST1700034	1 173,00
355/75	1150	335	70	ST1100035	1 275,00	ST1700035	1 173,00
355/90	1150	335	80	ST1100036	1 587,80	ST1700036	1 460,78
355/110	1150	335	90	ST1100037	1 587,80	ST1700037	1 460,78
355/125	1150	335	100	ST1100038	1 492,60	ST1700038	1 373,19
355/140	1150	325	90	ST1100039	1 761,20	ST1700039	1 620,30
355/160	1150	325	95	ST1100040	1 761,20	ST1700040	1 620,30
355/180	1150	325	100	ST1100041	1 905,70	ST1700041	1 753,24
355/200	1150	325	110	ST1100042	2 050,20	ST1700042	1 886,18
400/63	1230	360	65	ST1100043	1 686,40	ST1700043	1 551,49
400/75	1230	360	70	ST1100044	1 686,40	ST1700044	1 551,49
400/90	1230	360	80	ST1100045	1 999,20	ST1700045	1 839,26
400/110	1230	360	90	ST1100046	1 999,20	ST1700046	1 839,26
400/125	1230	360	100	ST1100047	1 904,00	ST1700047	1 751,68
400/140	1230	350	90	ST1100048	2 172,60	ST1700048	1 998,79
400/160	1230	350	95	ST1100049	2 172,60	ST1700049	1 998,79
400/180	1230	350	100	ST1100050	2 317,10	ST1700050	2 131,73
400/200	1230	350	110	ST1100051	2 699,60	ST1700051	2 483,63
450/63	1350	385	65	ST1100052	2 261,00	ST1700052	2 080,12
450/75	1350	385	70	ST1100053	2 261,00	ST1700053	2 080,12
450/90	1350	385	80	ST1100054	2 570,40	ST1700054	2 364,77
450/110	1350	385	90	ST1100055	2 570,40	ST1700055	2 364,77
450/125	1350	385	100	ST1100056	2 475,20	ST1700056	2 277,18
450/140	1350	375	90	ST1100057	2 743,80	ST1700057	2 524,30
450/160	1350	375	95	ST1100058	2 743,80	ST1700058	2 524,30
450/180	1350	375	100	ST1100059	2 983,50	ST1700059	2 744,82
450/200	1350	375	110	ST1100060	3 274,20	ST1700060	3 012,26

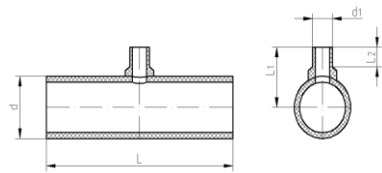

500/63	1500	410	65	ST1100061	2 956,30	ST1700061	2 719,80
500/75	1500	410	70	ST1100062	2 956,30	ST1700062	2 719,80
500/90	1500	410	80	ST1100063	3 267,40	ST1700063	3 006,01
500/110	1500	410	90	ST1100064	3 267,40	ST1700064	3 006,01
500/125	1500	410	100	ST1100065	3 170,50	ST1700065	2 916,86
500/140	1500	400	90	ST1100066	3 439,10	ST1700066	3 163,97
500/160	1500	400	95	ST1100067	3 439,10	ST1700067	3 163,97
500/180	1500	400	100	ST1100068	3 678,80	ST1700068	3 384,50
500/200	1500	400	110	ST1100069	3 967,80	ST1700069	3 650,38
560/63	1670	440	65	ST1100070	4 304,40	ST1700070	3 960,05
560/75	1670	440	70	ST1100071	4 304,40	ST1700071	3 960,05
560/90	1670	440	80	ST1100072	4 613,80	ST1700072	4 244,70
560/110	1670	440	90	ST1100073	4 613,80	ST1700073	4 244,70
560/125	1670	440	100	ST1100074	4 518,60	ST1700074	4 157,11
560/140	1670	430	90	ST1100075	4 787,20	ST1700075	4 404,22
560/160	1670	430	95	ST1100076	4 787,20	ST1700076	4 404,22
560/180	1670	430	100	ST1100077	5 026,90	ST1700077	4 624,75
560/200	1670	430	110	ST1100078	5 315,90	ST1700078	4 890,63
630/63	1750	475	65	ST1100079	5 851,40	ST1700079	5 383,29
630/75	1750	475	70	ST1100080	5 851,40	ST1700080	5 383,29
630/90	1750	475	80	ST1100081	6 162,50	ST1700081	5 669,50
630/110	1750	475	90	ST1100082	6 162,50	ST1700082	5 669,50
630/125	1750	475	100	ST1100083	6 069,00	ST1700083	5 583,48
630/140	1750	465	90	ST1100084	6 337,60	ST1700084	5 830,59
630/160	1750	465	95	ST1100085	6 337,60	ST1700085	5 830,59
630/180	1750	465	100	ST1100086	6 568,80	ST1700086	6 043,30
630/200	1750	465	110	ST1100087	6 873,10	ST1700087	6 323,25

Trójnik siodłowy PE100 redukcyjny 90st. kołnierzowy

d/d1	[±10]L	[±10]L1	SDR11		SDR17	
			index	cena	index	cena
200/63	660		SK1100001	835,13	SK1700001	768,32
200/75	660	380	SK1100002	835,13	SK1700002	768,32
200/90	660	400	SK1100003	1 105,00	SK1700003	1 016,60
200/110	660	400	SK1100004	1 105,00	SK1700004	1 016,60
200/125	660	410	SK1100005	1 105,00	SK1700005	1 016,60
225/63	710	365	SK1100006	926,50	SK1700006	852,38
225/75	710	390	SK1100007	926,50	SK1700007	852,38
225/90	710	410	SK1100008	1 194,25	SK1700008	1 098,71
225/110	710	410	SK1100009	1 194,25	SK1700009	1 098,71
225/125	710	420	SK1100010	1 194,25	SK1700010	1 098,71
250/63	850	400	SK1100011	1 115,63	SK1700011	1 026,38
250/75	850	405	SK1100012	1 115,63	SK1700012	1 026,38
250/90	850	425	SK1100013	1 383,38	SK1700013	1 272,71
250/110	850	425	SK1100014	1 383,38	SK1700014	1 272,71
250/125	850	435	SK1100015	1 383,38	SK1700015	1 272,71
250/140	850	410	SK1100016	1 540,63	SK1700016	1 417,38
250/160	850	445	SK1100017	1 540,63	SK1700017	1 417,38
280/63	890	415	SK1100018	1 260,13	SK1700018	1 159,32
280/75	890	420	SK1100019	1 260,13	SK1700019	1 159,32
280/90	890	440	SK1100020	1 530,00	SK1700020	1 407,60
280/110	890	440	SK1100021	1 530,00	SK1700021	1 407,60
280/125	890	450	SK1100022	1 530,00	SK1700022	1 407,60
280/140	890	425	SK1100023	1 687,25	SK1700023	1 552,27
280/160	890	460	SK1100024	1 687,25	SK1700024	1 552,27
315/63	1030	435	SK1100025	1 302,63	SK1700025	1 198,42
315/75	1030	440	SK1100026	1 302,63	SK1700026	1 198,42
315/90	1030	460	SK1100027	1 572,50	SK1700027	1 446,70
315/110	1030	460	SK1100028	1 572,50	SK1700028	1 446,70
315/125	1030	470	SK1100029	1 572,50	SK1700029	1 446,70
315/140	1030	445	SK1100030	1 906,13	SK1700030	1 753,64
315/160	1030	470	SK1100031	1 906,13	SK1700031	1 753,64
315/180	1030	470	SK1100032	2 088,88	SK1700032	1 921,77
315/200	1030	460	SK1100033	2 452,25	SK1700033	2 256,07
355/63	1150	450	SK1100034	1 593,75	SK1700034	1 466,25
355/75	1150	455	SK1100035	1 593,75	SK1700035	1 466,25
355/90	1150	475	SK1100036	1 984,75	SK1700036	1 825,97
355/110	1150	475	SK1100037	1 984,75	SK1700037	1 825,97
355/125	1150	485	SK1100038	1 865,75	SK1700038	1 716,49
355/140	1150	450	SK1100039	2 201,50	SK1700039	2 025,38
355/160	1150	485	SK1100040	2 201,50	SK1700040	2 025,38
355/180	1150	485	SK1100041	2 382,13	SK1700041	2 191,56
355/200	1150	475	SK1100042	2 562,75	SK1700042	2 357,73
400/63	1230	475	SK1100043	2 108,00	SK1700043	1 939,36
400/75	1230	480	SK1100044	2 108,00	SK1700044	1 939,36
400/90	1230	500	SK1100045	2 499,00	SK1700045	2 299,08
400/110	1230	500	SK1100046	2 499,00	SK1700046	2 299,08
400/125	1230	510	SK1100047	2 380,00	SK1700047	2 189,60
400/140	1230	485	SK1100048	2 715,75	SK1700048	2 498,49
400/160	1230	510	SK1100049	2 715,75	SK1700049	2 498,49
400/180	1230	510	SK1100050	2 896,38	SK1700050	2 664,67
400/200	1230	500	SK1100051	3 374,50	SK1700051	3 104,54
450/63	1350	535	SK1100052	2 826,25	SK1700052	2 600,15
450/75	1350	535	SK1100053	2 826,25	SK1700053	2 600,15
450/90	1350	525	SK1100054	3 213,00	SK1700054	2 955,96
450/110	1350	525	SK1100055	3 213,00	SK1700055	2 955,96
450/125	1350	535	SK1100056	3 094,00	SK1700056	2 846,48
450/140	1350	500	SK1100057	3 429,75	SK1700057	3 155,37
450/160	1350	535	SK1100058	3 429,75	SK1700058	3 155,37
450/180	1350	535	SK1100059	3 729,38	SK1700059	3 431,03
450/200	1350	525	SK1100060	4 092,75	SK1700060	3 765,33

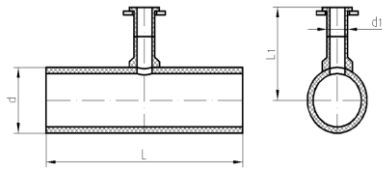

500/63	1500	525	SK1100061	3 695,38	SK1700061	3 399,75
500/75	1500	530	SK1100062	3 695,38	SK1700062	3 399,75
500/90	1500	550	SK1100063	4 084,25	SK1700063	3 757,51
500/110	1500	550	SK1100064	4 084,25	SK1700064	3 757,51
500/125	1500	560	SK1100065	3 963,13	SK1700065	3 646,08
500/140	1500	525	SK1100066	4 298,88	SK1700066	3 954,97
500/160	1500	560	SK1100067	4 298,88	SK1700067	3 954,97
500/180	1500	560	SK1100068	4 598,50	SK1700068	4 230,62
500/200	1500	550	SK1100069	4 959,75	SK1700069	4 562,97
560/63	1670	555	SK1100070	5 380,50	SK1700070	4 950,06
560/75	1670	560	SK1100071	5 380,50	SK1700071	4 950,06
560/90	1670	580	SK1100072	5 767,25	SK1700072	5 305,87
560/110	1670	580	SK1100073	5 767,25	SK1700073	5 305,87
560/125	1670	590	SK1100074	5 648,25	SK1700074	5 196,39
560/140	1670	555	SK1100075	5 984,00	SK1700075	5 505,28
560/160	1670	590	SK1100076	5 984,00	SK1700076	5 505,28
560/180	1670	590	SK1100077	6 283,63	SK1700077	5 780,94
560/200	1670	580	SK1100078	6 644,88	SK1700078	6 113,29
630/63	1750	590	SK1100079	7 314,25	SK1700079	6 729,11
630/75	1750	595	SK1100080	7 314,25	SK1700080	6 729,11
630/90	1750	615	SK1100081	7 703,13	SK1700081	7 086,88
630/110	1750	615	SK1100082	7 703,13	SK1700082	7 086,88
630/125	1750	625	SK1100083	7 586,25	SK1700083	6 979,35
630/140	1750	590	SK1100084	7 922,00	SK1700084	7 288,24
630/160	1750	625	SK1100085	7 922,00	SK1700085	7 288,24
630/180	1750	625	SK1100086	8 211,00	SK1700086	7 554,12
630/200	1750	615	SK1100087	8 591,38	SK1700087	7 904,07

KSZTAŁTKI WTRYSKOWE DOCZOŁOWE DO WODY I KANALIZACJI CIŚNIENIOWEJ PE100

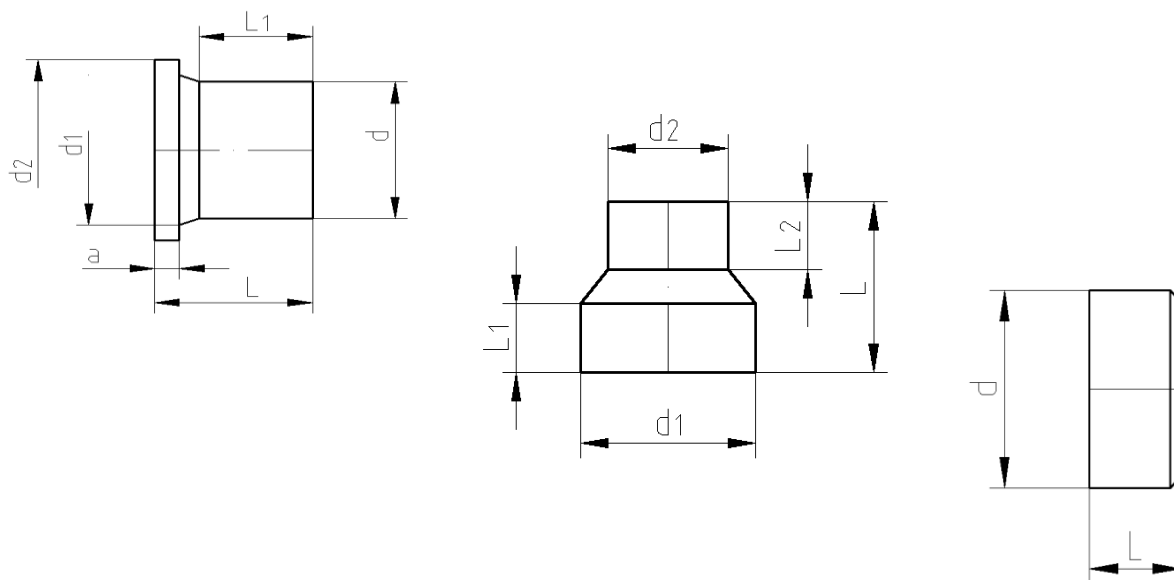

Specyfikacja techniczna

Budowa kształtki:	Tuleje, redukcje, zaślepki – gładkie jednowarstwowe
Przeznaczenie:	kształtki polietylenowe przeznaczone do przesyłania wody i kanalizacji ciśnieniowej
Kolor:	czarny
Normy produktu:	PN-EN 12201-3+A1
Materiał:	PE 100, PE 100 RC
Wymiary:	Ø50 do Ø630; SDR 11, SDR 17
Klasyfikacja statystyczna wyrobu:	PKWiU 25.21-21-53-10
Forma dostawy:	pakowane zbiorczo lub osobno w opakowania kartonowe lub foliowe
Dopuszczenia:	aktualne dokumenty odniesienia znajdują się na stronie www.zinplast.pl

Tuleja kołnierzowa PE100 długa

d	L [±5]	L1 [±5]	d1 [-2]	d2 [-1]	SDR11			SDR17		
					a [+2]	index	cena	a [+2]	index	cena
50	95	65	61	88	12	TW1100050	17,00	12	TW1700050	16,00
63	115	70	75	102	14	TW1100063	18,20	14	TW1700063	17,10
75	120	80	89	122	16	TW1100075	22,00	16	TW1700075	20,74
90	140	95	105	138	17	TW1100090	27,26	17	TW1700090	23,80
110	155	100	125	158	18	TW1100110	33,70	18	TW1700110	29,00
125	142	120	125	158	25	TW1100125	42,00	18	TW1700125	37,54
140	160	105	155	188	25	TW1100140	51,00	18	TW1700140	51,00
160	160	115	175	212	25	TW1100160	54,44	18	TW1700160	51,84
180	150	120	180	212	30	TW1100180	87,00	20	TW1700180	87,00
200	200	135	232	268				24	TW1700200	106,00
225	200	135	235	268				24	TW1700225	115,20
355	250	180	373	430				30	TW1700355	537,00

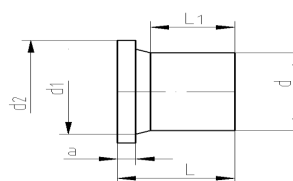

Tuleja kołnierzowa PE100 krótka

d	L [±5]	L1 [±5]	d1 [-2]	d2 [-1]	SDR11			SDR17		
					a [+2]	index	cena	a [+2]	index	cena
200	140	85	232	268	32	TW1110200	111,36	24	TW1700200	106,00
225	150	95	235	268	32	TW1110225	124,00	24	TW1700225	115,20
250	150	85	285	320	35	TW1100250	186,44	25	TW1700250	159,26
280	155	105	291	320	35	TW1100280	261,50	25	TW1700280	240,76
315	155	90	335	370	35	TW1100315	323,02	25	TW1700315	284,84
355	125	75	373	430	40	TW1110355	618,00	30	TW1700355	537,00
400	125	70	427	482	46	TW1100400	1 065,05	34	TW1700400	1 065,05
450/450	135	65	472	530	46	TW1100451	1 784,00	46	TW1700451	1 552,00
450	135	65	514	585	60	TW1100450	1 204,11	46	TW1700450	1 275,00
500	150	70	530	585	60	TW1100500	1 808,12	46	TW1700500	1 719,00
560	150	70	615	685	60	TW1100560	2 083,01	50	TW1700560	1 981,32
630	145	75	642	685	60	TW1100630	2 225,81	50	TW1700630	2 225,81

Redukcja centryczna PE100 wtryskowa

d/d1	L [±5]	L1 [±5]	L2 [±5]	SDR11		SDR17	
				index	cena	index	cena
90/63	130	50	55	RW1100001	40,42	RW1700001	40,42
90/75	130	45	55	RW1100002	40,00	RW1700002	40,00
110/63	140	50	60	RW1100003	42,00	RW1700003	42,00
110/75	135	45	60	RW1100004	42,00	RW1700004	42,00
110/90	135	50	60	RW1100005	45,00	RW1700005	45,00
125/63	120	40	45	RW1100006	61,70	RW1700006	64,00
125/75	120	40	50	RW1100007	65,00	RW1700007	65,45
125/90	120	40	50	RW1100008	68,30	RW1700008	65,45
125/110	120	40	50	RW1100009	68,30	RW1700009	66,13
140/63	135	50	50	RW1100010	113,00	RW1700010	113,00
140/90	135	50	50	RW1100011	101,00	RW1700011	101,98
140/110	135	50	50	RW1100012	101,00	RW1700012	101,98
140/125	135	50	50	RW1100013	112,00	RW1700013	104,13
160/63	135	50	50	RW1100014	125,46	RW1700014	125,46
160/75	135	50	50	RW1100015	125,46	RW1700015	125,46
160/90	130	45	45	RW1100016	118,23	RW1700016	61,00
160/110	150	55	60	RW1100017	118,23	RW1700017	123,00
160/125	135	50	50	RW1100018	118,23	RW1700018	123,00
160/140	135	50	50	RW1100019	123,00	RW1700019	123,00
180/160	115	50	60	RW1100020	157,00	RW1700020	135,36
200/160	145	55	50	RW1100021	158,00	RW1700021	147,00
225/160	145	55	50	RW1100022	209,00	RW1700022	227,00
200/180	115	50	40	RW1100023	213,00	RW1700023	213,00
225/180	115	50	40	RW1100024	285,16	RW1700024	265,08
225/200	110	50	50	RW1100025	224,00	RW1700025	209,00
250/160	155	50	60	RW1100026	307,00	RW1700026	265,08
250/200	120	50	50	RW1100027	307,00	RW1700027	279,00
250/225	115	50	55	RW1100028	332,00	RW1700028	268,00
280/225	135	40	30	RW1100029	428,06	RW1700029	428,06
280/250	80	30	30	RW1100030	467,00	RW1700030	425,00
315/225	175	35	30	RW1100031	464,61	RW1700031	464,61
315/250	130	35	30	RW1100032	544,17	RW1700032	544,17
315/280	80	35	30	RW1100033	549,23	RW1700033	446,25
355/315	100	45	30	RW1100034	774,35	RW1700034	774,35
400/315	150	45	30	RW1100035	872,27	RW1700035	872,27
400/355	95	45	30	RW1100036	1 052,13	RW1700036	1 053,66
450/315	200	45	30	RW1100037	1 369,86	RW1700037	1 369,86
450/355	150	45	30	RW1100038	1 408,11	RW1700038	1 408,11
450/400	95	45	30	RW1100039	1 461,66	RW1700039	1 461,66
500/450	90	35	30	RW1100040		RW1700040	2 079,00
560/450	115	35	30	RW1100041		RW1700041	3 201,00
560/500	90	35	25	RW1100042		RW1700042	2 877,00
630/450	180	40	30	RW1100043		RW1700043	4 157,00
630/500	125	40	25	RW1100044		RW1700044	4 200,00
630/560	85	40	25	RW1100045		RW1700045	4 250,00

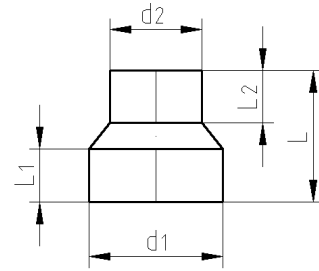

Zaślepka PE100 wtryskowa

d	L [±5]	SDR11		SDR17	
		index	cena	index	cena
90	55	ZW1100090	24,58	ZW1700090	27,50
110	60	ZW1100110	37,34	ZW1700110	33,22
125	50	ZW1100125	44,26	ZW1700125	44,26
140	50	ZW1100140	70,00	ZW1700140	99,94
160	85	ZW1100160	77,00	ZW1700160	75,26
180	65	ZW1100180	111,00	ZW1700180	144,94
200	60	ZW1100200	130,00	ZW1700200	160,40
225	65	ZW1100225	149,00	ZW1700225	193,63
250	65	ZW1100250	215,90	ZW1700250	215,90
280	60	ZW1100280	241,06	ZW1700280	241,06
315	60	ZW1100315	284,41	ZW1700315	284,41

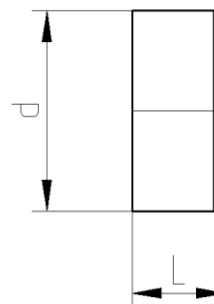

KSZTAŁTKI ELEKTROOPOROWE DO WODY I KANALIZACJI CIŚNIENIOWEJ PE100

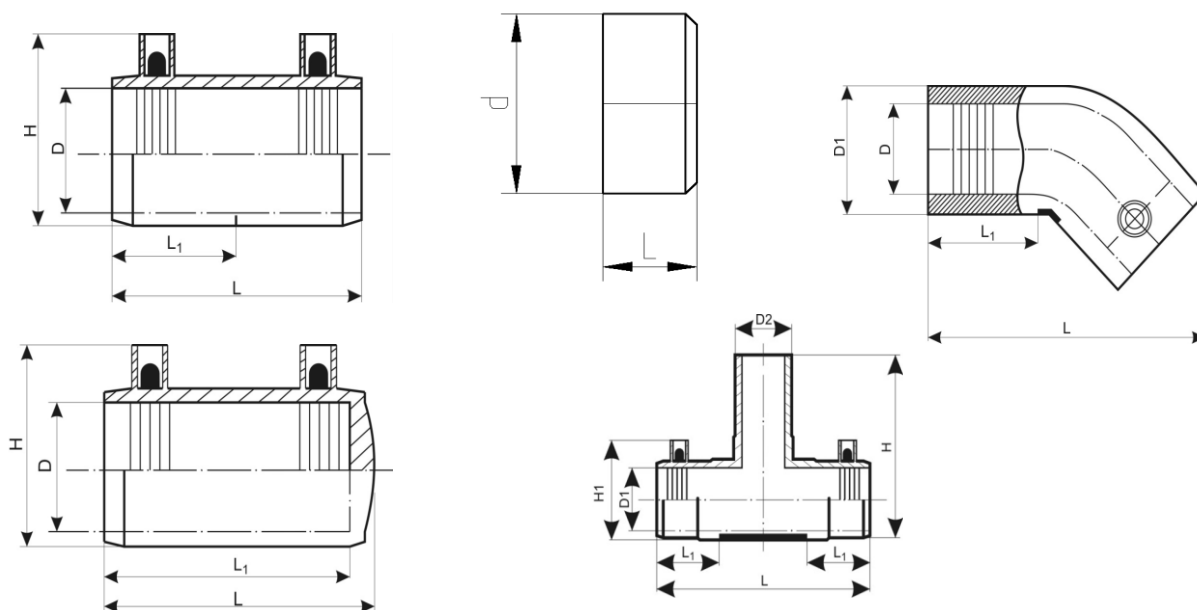

Specyfikacja techniczna

Budowa kształtki:	mufy, łuki, zaślepki – gładkie jednowarstwowe
Przeznaczenie:	kształtki polietylenowe przeznaczone do przesyłania wody i kanalizacji ciśnieniowej
Kolor:	czarny
Normy produktu:	PN-EN 12201-3
Materiał:	PE 100, PE 100 RC
Wymiary:	Ø20 do Ø400; SDR 11, SDR 17
Klasyfikacja statystyczna wyrobu:	PKWiU 22.21.29-70
Forma dostawy:	pakowane zbiorczo lub osobno w opakowania kartonowe lub foliowe
Dopuszczenia:	aktualne dokumenty odniesienia znajdują się na stronie www.zinplast.pl

Mufa elektrooporowa PE100

D	SDR17				SDR11			
	L	L1	index	cena	L	L1	index	cena
20					68	33	ME1100020	9,18
25					74	36	ME1100025	12,10
32					74	35	ME1100032	13,10
40					106	51	ME1100040	15,12
50					118	57	ME1100050	20,16
63					98	47	ME1100063	23,18
75					118	58	ME1100075	35,28
90					145	70	ME1100090	41,33
110	146	70	ME1700110	46,37	147	70	ME1100110	51,41
125	166	80	ME1700125	68,54	166	80	ME1100125	75,60
140	174	84	ME1700140	84,67	174	84	ME1100140	91,73
160	183	89	ME1700160	91,73	180	87	ME1100160	100,80
180	195	93	ME1700180	121,97	200	96	ME1100180	146,16
200	209	103	ME1700200	154,22	218	105	ME1100200	170,35
225	218	107	ME1700225	201,60	231	113	ME1100225	224,78
250	227	110	ME1700250	275,18	246	120	ME1100250	253,28
280	250	122	ME1700280	328,68	127	120	ME1100280	365,42
315	261	127	ME1700315	345,12	272	127	ME1100315	382,82
400	305	148	ME1700400	773,38	310	155	ME1100400	1 349,11

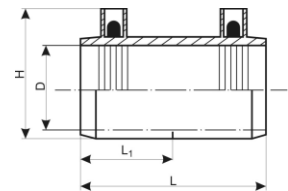

Zaślepka elektrooporowa PE100 SDR11

D	L	L1	index	cena
20	68	33	ZE0000020	15,47
25	74	36	ZE0000025	19,15
32	74	35	ZE0000032	20,16
40	106	51	ZE0000040	22,18
50	118	57	ZE0000050	29,23
63	98	47	ZE0000063	33,26
75	118	58	ZE0000075	47,38
90	145	70	ZE0000090	54,43
110	147	70	ZE0000110	73,58
125	166	80	ZE0000125	139,10
140	174	84	ZE0000140	235,55
160	180	87	ZE0000160	216,72
180	200	96	ZE0000180	496,39
200	218	105	ZE0000200	595,64
225	231	113	ZE0000225	735,35
250	246	120	ZE0000250	939,62
280	246	120	ZE0000280	1 345,23
315	272	127	ZE0000315	1 622,53

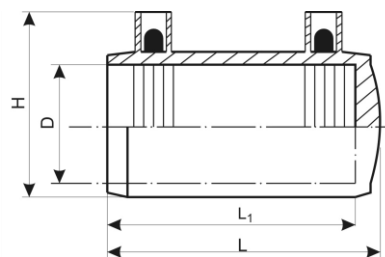

Łuk elektrooporowy PE100 SDR11 45st.

D	L	L1	index	cena
25	103	40	KE4500025	32,26
32	121	43	KE4500032	33,26
40	135	47	KE4500040	44,35
50	153	53	KE4500050	52,42
63	178	61	KE4500063	59,47
75	183	62	KE4500075	92,74
90	200	74	KE4500090	96,77
110	226	74	KE4500110	140,11
125	231	76	KE4500125	200,59
140	340	92	KE4500140	322,46
160	295	90	KE4500160	305,42
180	435	105	KE4500180	700,90
200	472	115	KE4500200	1 031,70
225	529	120	KE4500225	1 240,80
250	571	130	KE4500250	2 200,06

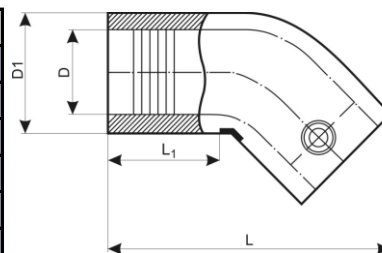

Łuk elektrooporowy PE100 SDR11 90st.

D	L	L1	index	cena
32	81	37	KE9000032	33,26
40	112	54	KE9000040	44,35
50	116	53	KE9000050	52,42
63	125	49	KE9000063	59,47
75	160	69	KE9000075	92,74
90	165	65	KE9000090	96,77
110	200	73	KE9000110	140,11
125	230	87	KE9000125	200,59
140	238	75	KE9000140	258,05
160	272	90	KE9000160	305,42
180	320	106	KE9000180	489,16
200	337	110	KE9000200	651,57
225	410	153	KE9000225	968,65
250	550	130	KE9000250	2 076,70

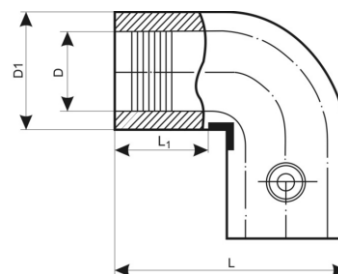

Redukcja elektrooporowa PE100 SDR11

D1/D2	L	L1	L2	index	cena
25/20	79	32	32	RE0000001	17,14
32/20	76	30	41	RE0000002	18,14
32/25	105	39	62	RE0000003	18,14
40/25	89	31	40	RE0000004	22,18
40/32	116	40	48	RE0000005	24,19
50/25	92	32	40	RE0000006	28,22
50/32	129	48	55	RE0000007	29,23
50/40	129	48	55	RE0000008	30,24
63/25	125	42	57	RE0000009	36,29
63/32	125	42	57	RE0000010	36,29
63/40	128	49	58	RE0000011	36,29
63/50	128	49	58	RE0000012	36,29
75/50	156	58	72	RE0000013	70,56
75/63	156	58	72	RE0000014	70,56
90/63	170	58	77	RE0000015	73,58
90/75	156	69	78	RE0000016	101,81
110/63	205	73	90	RE0000017	103,82
110/90	173	75	86	RE0000018	103,82
125/90	216	85	89	RE0000019	108,86
125/110	224	89	98	RE0000020	108,86
140/125	224	91	100	RE0000021	123,98
160/90	173	75	70	RE0000022	319,64
160/110	227	89	115	RE0000023	137,09
160/125	233	92	100	RE0000024	151,20
160/140	233	95	99	RE0000025	164,30
180/125	212	70	96	RE0000026	268,75
200/160	243	90	110	RE0000027	517,20
225/160	243	84	110	RE0000028	568,43

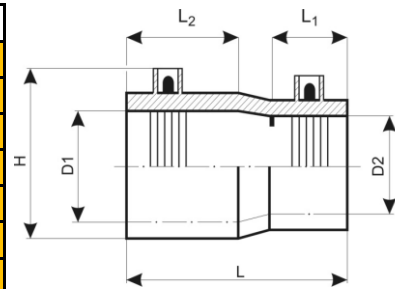

Redukcja elektrooporowa PE100 SDR11

D1/D2	L	L1	H	index	cena
25/25	106	39	85	TE0000001	28,03
32/32	106	35	44	TE0000002	34,27
40/40	111	39	110	TE0000003	44,35
50/50	153	53	58	TE0000004	54,43
63/63	175	60	145	TE0000005	58,46
75/75	194	66	175	TE0000006	85,68
90/90	223	69	204	TE0000007	105,84
110/110	242	72	228	TE0000008	164,30
125/125	275	72	260	TE0000009	207,65
140/140	304	78	111	TE0000010	217,51
160/160	321	78	100	TE0000011	319,02
180/180	420	90	110	TE0000012	901,40
200/200	450	104	115	TE0000013	1 686,03
225/225	495	110	120	TE0000014	1 985,56
250/250	540	122	145	TE0000015	2 908,40

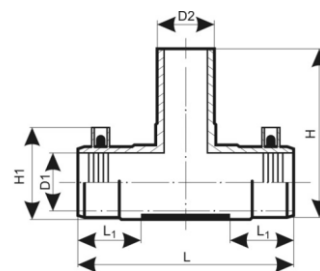

Akcesoria DO WODY I KANALIZACJI CIŚNIENIOWEJ PE100

Budowa kształtki:	Kołnierze stalowe, uszczelki
Przeznaczenie:	akcesoria do instalacji przesyłania wody i kanalizacji ciśnieniowej
Wymiary:	Ø50 do Ø630; PN10, PN16
Forma dostawy:	pakowane zbiorczo lub osobno w opakowania kartonowe lub foliowe
Dopuszczenia:	aktualne dokumenty odniesienia znajdują się na stronie www.zinplast.pl

Kolnierze stalowe galwanizowane

PN16								
DN/d	Dz	Dw	Dp	B	dp	ilość otworów	index	cena
40/50	150	63	110	16	18	4	GE1600001	55,94
50/63	165	78	125	16	18	4	GE1600002	62,74
65/75	185	92	145	16	18	4	GE1600003	72,89
80/90	200	108	160	18	18	8	GE1600004	91,45
100/110	220	135	180	18	18	8	GE1600005	106,90
100/125	220	135	180	18	18	8	GE1600006	100,35
125/125	250	135	210	18	18	8	GE1600007	144,05
125/140	250	158	210	18	18	8	GE1600008	124,87
150/160	285	178	240	20	22	8	GE1600009	162,31
150/180	285	186	240	20	22	8	GE1600010	149,04
200/200	340	236	295	20	22	12	GE1600011	236,76
200/225	340	238	295	20	22	12	GE1600012	239,20
250/250	405	289	355	29	26	12	GE1600013	393,30
250/280	405	295	355	29	26	12	GE1600014	365,22
300/315	460	339	410	34	26	12	GE1600015	568,97
350/355	520	377	470	39	26	16	GE1600016	844,10
400/400	580	421	525	41	30	16	GE1600017	936,10
450/450	670	517	585	42	33	20	GE1600018	1 136,20
500/450	715	517	650	42	33	20	GE1600019	1 754,90
500/500	715	533	650	42	33	20	GE1600020	1 449,00
600/560	840	618	770	48	33	20	GE1600021	2 799,10
600/630	840	645	770	48	33	20	GE1600022	2 783,00
PN10								
DN/d	Dz	Dw	Dp	B	dp	ilość otworów	index	cena
40/50	150	63	110	16	18	4	GE1000001	55,94
50/63	165	78	125	16	18	4	GE1000002	62,74
65/75	185	92	145	16	18	4	GE1000003	72,89
80/90	200	108	160	18	18	8	GE1000004	91,45
100/110	220	128	180	18	18	8	GE1000005	106,90
100/125	220	128	180	18	18	8	GE1000006	100,35
125/125	250	135	210	18	18	8	GE1000007	144,05
125/140	250	158	210	18	18	8	GE1000008	87,40
150/160	285	178	240	20	22	8	GE1000009	162,31
150/180	285	178	240	20	22	8	GE1000010	149,04
200/200	340	236	295	20	22	8	GE1000011	215,81
200/225	340	238	295	20	22	12	GE1000012	216,94
250/250	395	289	350	24	22	12	GE1000013	302,77
250/280	395	295	350	24	22	12	GE1000014	287,18
300/315	445	339	400	28	22	12	GE1000015	430,17
350/355	505	377	460	30	22	16	GE1000016	556,09
400/400	565	421	515	32	26	16	GE1000017	676,20
450/450	615	470	565	35	26	20	GE1000018	982,10
500/450	670	517	620	38	26	20	GE1000019	961,40
500/500	670	533	620	38	26	33	GE1000020	1 143,10
600/560	780	618	725	44	30	20	GE1000021	1 679,00
600/630	780	645	725	44	30	20	GE1000022	1 683,60

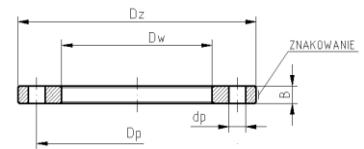

Uszczelka gumowa płaska

DN	index	cena
40	UG0000040	2,40
50	UG0000050	2,40
65	UG0000065	2,64
80	UG0000080	3,12
100	UG0000100	3,36
125	UG0000125	4,80
150	UG0000150	5,52
200	UG0000200	9,12
250	UG0000250	11,04
300	UG0000300	14,88
350	UG0000350	19,20
400	UG0000400	31,20
500	UG0000500	45,60
600	UG0000600	143,00

