

KSZTAŁTKI

DO INSTALACJI WODNO-KANALIZACYJNYCH

Ceny obowiązują od 15.06.2021

podane ceny nie zawierają podatku VAT

KSZTAŁTKI SEGMENTOWE DO WODY I KANALIZACJI CIŚNIENIOWEJ PE100, PE 100 RC

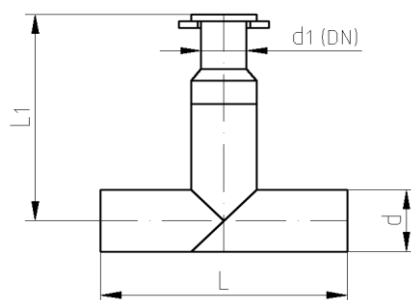
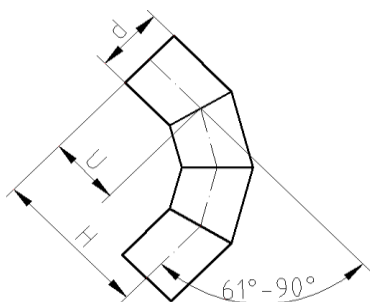
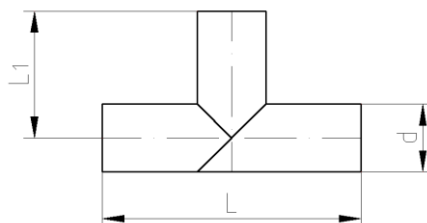
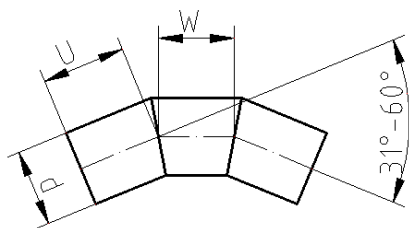

Specyfikacja techniczna

Budowa kształtki:	kształtki segmentowe jednowarstwowe i dwuwarstwowe
Przeznaczenie:	kształtki polietylenowe przeznaczone do wody I kanalizacji ciśnieniowej
Kolor:	Woda - czarny z niebieskimi paskami, Kanalizacja – czarny, czarny z brązowymi paskami Woda RC – kolor granatowy/czarny, czarny z niebieskimi paskami/czarny Kanalizacja RC - kolor czarny/ czarny, brązowy/czarny
Normy produktu:	PN EN 12201-3+A1
Materiał:	PE 100, PE 100 RC
Wymiary:	Ø90 do Ø 630 ; SDR 41 do SDR 7,4
Klasyfikacja statystyczna wyrobu:	PKWiU 25.21-21-53-10
Forma dostawy:	pakowane zbiorczo lub osobno w opakowania kartonowe lub foliowe
Dopuszczenia:	aktualne dokumenty odniesienia znajdują się na stronie www.zinplast.pl

Łuk segmentowy PE100 1-30st.

d	SDR11		SDR17	
	index	cena	index	cena
90	LS1130090	40,00	LS1730090	32,00
110	LS1130110	54,10	LS1730170	42,10
125	LS1130125	65,90	LS1730125	50,10
140	LS1130140	80,00	LS1730140	61,90
160	LS1130160	97,80	LS1730160	78,00
180	LS1130180	118,10	LS1730180	94,20
200	LS1130200	149,90	LS1730200	111,70
225	LS1130225	188,40	LS1730225	140,40
250	LS1130250	297,20	LS1730250	190,10
280	LS1130280	370,80	LS1730280	238,30
315	LS1130315	456,60	LS1730315	324,80
355	LS1130355	695,50	LS1730355	458,90
400	LS1130400	889,20	LS1730400	620,20
450	LS1130450	1 536,40	LS1730450	1 012,40
500	LS1130500	2 139,40	LS1730500	1 354,30
560	LS1130560	2 903,40	LS1730560	1 845,90
630	LS1130630	3 691,80	LS1730630	2 461,20

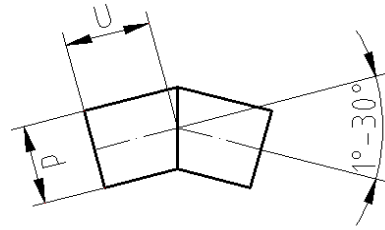

Łuk segmentowy PE100 31-60st.

d	SDR11		SDR17	
	index	cena	index	cena
90	LS1160090	71,90	LS1760090	56,00
110	LS1160110	84,20	LS1760110	72,00
125	LS1160125	105,90	LS1760125	88,20
140	LS1160140	128,00	LS1760140	108,00
160	LS1160160	162,30	LS1760160	138,00
180	LS1160180	206,60	LS1760180	163,70
200	LS1160200	246,30	LS1760200	198,00
225	LS1160225	302,40	LS1760225	234,50
250	LS1160250	453,80	LS1760250	299,90
280	LS1160280	537,40	LS1760280	370,90
315	LS1160315	682,20	LS1760315	467,80
355	LS1160355	970,00	LS1760355	669,90
400	LS1160400	1 251,10	LS1760400	959,50
450	LS1160450	2 333,80	LS1760450	1 395,90
500	LS1160500	3 076,50	LS1760500	2 029,80
560	LS1160560	3 436,60	LS1760560	2 787,00
630	LS1160630	5 574,10	LS1760630	3 691,80

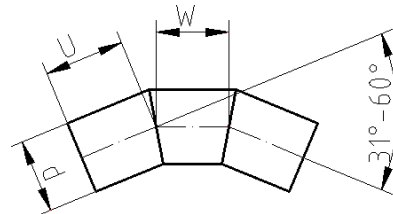

Łuk segmentowy PE100 61-90st.

d	SDR11		SDR17	
	index	cena	index	cena
90	LS1190090	101,80	LS1790090	82,20
110	LS1190110	119,80	LS1790110	102,00
125	LS1190125	154,10	LS1790125	127,70
140	LS1190140	180,30	LS1790140	148,10
160	LS1190160	221,40	LS1790160	187,90
180	LS1190180	298,80	LS1790180	241,70
200	LS1190200	339,70	LS1790200	277,90
225	LS1190225	415,00	LS1790225	345,00
250	LS1190250	551,90	LS1790250	424,70
280	LS1190280	711,10	LS1790280	523,60
315	LS1190315	913,50	LS1790315	632,40
355	LS1190355	1 286,60	LS1790355	910,40
400	LS1190400	1 648,00	LS1790400	1 286,20
450	LS1190450	2 969,20	LS1790450	1 820,90
500	LS1190500	3 939,20	LS1790500	2 524,70
560	LS1190560	5 230,00	LS1790560	3 384,10
630	LS1190630	7 075,90	LS1790630	4 614,70

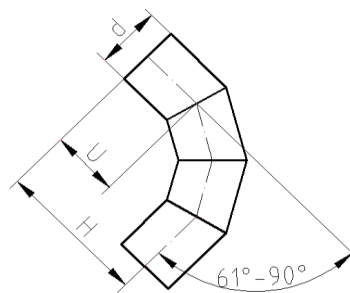

Trójnik segmentowy PE100 90st.

d	SDR11		SDR17	
	index	cena	index	cena
90	TS1190090	84,20	TS1790090	65,80
110	TS1190110	106,00	TS1790110	87,90
125	TS1190125	128,00	TS1790125	105,90
140	TS1190140	163,60	TS1790140	133,90
160	TS1190160	195,60	TS1790160	163,70
180	TS1190180	264,50	TS1790180	212,70
200	TS1190200	318,10	TS1790200	258,70
225	TS1190225	392,20	TS1790225	256,10
250	TS1190250	537,70	TS1790250	398,80
280	TS1190280	673,60	TS1790280	494,30
315	TS1190315	1 264,40	TS1790315	731,60
355	TS1190355	1 636,80	TS1790355	1 049,00
400	TS1190400	2 012,90	TS1790400	1 411,70
450	TS1190450	3 691,80	TS1790450	2 322,50
500	TS1190500	6 679,20	TS1790500	3 278,90
560	TS1190560	9 168,70	TS1790560	4 404,20
630	TS1190630	11 820,20	TS1790630	6 055,80

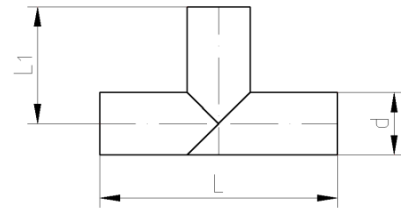

Trójnik segmentowy PE100 60st.

d	SDR11		SDR17	
	index	cena	index	cena
90	TS1160090	127,70	TS1760090	114,10
110	TS1160110	156,40	TS1760110	142,30
125	TS1160125	197,60	TS1760125	166,30
140	TS1160140	244,80	TS1760140	201,70
160	TS1160160	299,90	TS1760160	244,80
180	TS1160180	400,90	TS1760180	320,70
200	TS1160200	472,70	TS1760200	385,00
225	TS1160225	589,70	TS1760225	457,10
250	TS1160250	784,30	TS1760250	566,30

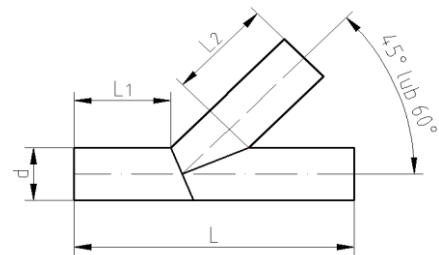

Trójnik segmentowy PE100 45st.

d	SDR11		SDR17	
	index	cena	index	cena
90	TS1145090	114,10	TS1745090	127,70
110	TS1145110	142,30	TS1745110	156,40
125	TS1145125	166,30	TS1745125	197,60
140	TS1145140	201,70	TS1745140	244,80
160	TS1145145	244,80	TS1745145	299,90
180	TS1145180	320,70	TS1745180	400,90
200	TS1145200	385,00	TS1745200	472,70

Trójnik segmentowy redukcyjny PE100 90st.

d/d1	SDR11		SDR17	
	index	cena	index	cena
90/63	TY1100001	143,80	TY1700001	139,70
90/75	TY1100002	143,80	TY1700002	139,70
110/63	TY1100003	175,60	TY1700003	164,00
110/75	TY1100004	175,60	TY1700004	164,00
110/90	TY1100005	175,60	TY1700005	164,00
125/63	TY1100006	214,70	TY1700006	188,30
125/75	TY1100007	214,70	TY1700007	188,30
125/90	TY1100008	213,70	TY1700008	191,40
125/110	TY1100009	213,70	TY1700009	191,40
140/63	TY1100010	285,70	TY1700010	260,40
140/90	TY1100011	285,70	TY1700011	260,40
140/110	TY1100012	269,40	TY1700012	221,80
140/125	TY1100013	285,70	TY1700013	260,40
160/63	TY1100014	326,90	TY1700014	322,50
160/75	TY1100015	326,90	TY1700015	322,50
160/90	TY1100016	329,00	TY1700016	304,20
160/110	TY1100017	329,00	TY1700017	304,20
160/125	TY1100018	329,00	TY1700018	304,20
160/140	TY1100019	329,00	TY1700019	304,20
180/63	TY1100020	527,90	TY1700020	490,80
180/75	TY1100021	527,90	TY1700021	490,80
180/90	TY1100022	472,70	TY1700022	436,10
180/110	TY1100023	472,70	TY1700023	436,10
180/125	TY1100024	472,70	TY1700024	439,00
180/140	TY1100025	472,70	TY1700025	439,00
180/160	TY1100026	459,00	TY1700026	428,80
200/63	TY1100027	693,10	TY1700027	644,00
200/75	TY1100028	693,10	TY1700028	644,00
200/90	TY1100029	620,20	TY1700029	612,00
200/110	TY1100030	620,20	TY1700030	612,00
200/125	TY1100031	620,20	TY1700031	612,00
200/140	TY1100032	620,20	TY1700032	612,00
200/160	TY1100033	599,80	TY1700033	557,00
200/180	TY1100034	599,80	TY1700034	557,00
225/63	TY1100035	855,60	TY1700035	790,50
225/75	TY1100036	855,60	TY1700036	790,50
225/90	TY1100037	825,40	TY1700037	761,10
225/110	TY1100038	825,40	TY1700038	761,10
225/125	TY1100039	825,40	TY1700039	761,10
225/140	TY1100040	825,40	TY1700040	761,10
225/160	TY1100041	742,50	TY1700041	688,20
225/180	TY1100042	670,80	TY1700042	639,00
225/200	TY1100043	670,80	TY1700043	639,00
250/63	TY1100044	1 021,50	TY1700044	982,70
250/75	TY1100045	1 021,50	TY1700045	982,70
250/90	TY1100046	1 014,00	TY1700046	963,70
250/110	TY1100047	1 014,00	TY1700047	963,70
250/125	TY1100048	1 053,00	TY1700048	982,70
250/140	TY1100049	949,00	TY1700049	982,70
250/160	TY1100050	948,50	TY1700050	858,00
250/180	TY1100051	950,50	TY1700051	856,10
250/200	TY1100052	950,50	TY1700052	841,30
250/225	TY1100053	950,50	TY1700053	841,30
280/63	TY1100054	1 388,90	TY1700054	1 234,90
280/75	TY1100055	1 388,90	TY1700055	1 234,90
280/90	TY1100056	1 388,90	TY1700056	1 223,10

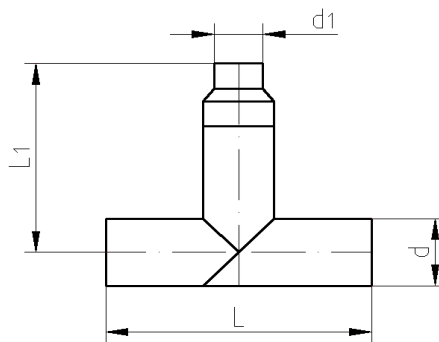

280/110	TY1100057	1 388,90	TY1700057	1 223,10
280/125	TY1100058	1 388,90	TY1700058	1 223,10
280/140	TY1100059	1 388,90	TY1700059	1 223,10
280/160	TY1100060	1 238,80	TY1700060	1 102,90
280/180	TY1100061	1 390,80	TY1700061	1 223,90
280/200	TY1100062	1 238,80	TY1700062	1 057,80
280/225	TY1100063	1 185,60	TY1700063	959,40
280/250	TY1100064	1 185,60	TY1700064	959,40
315/63	TY1100065	1 697,30	TY1700065	1 520,60
315/75	TY1100066	1 697,30	TY1700066	1 520,60
315/90	TY1100067	1 697,30	TY1700067	1 492,30
315/110	TY1100068	1 697,30	TY1700068	1 492,30
315/125	TY1100069	1 697,30	TY1700069	1 492,30
315/140	TY1100070	1 697,30	TY1700070	1 492,30
315/160	TY1100071	1 622,40	TY1700071	1 345,40
315/180	TY1100072	1 625,30	TY1700072	1 308,70
315/200	TY1100073	1 625,30	TY1700073	1 308,70
315/225	TY1100074	1 616,20	TY1700074	1 215,20
315/250	TY1100075	1 616,20	TY1700075	1 215,20
315/280	TY1100076	1 616,20	TY1700076	1 215,20
355/63	TY1100077	3 161,00	TY1700077	2 600,40
355/75	TY1100078	3 161,00	TY1700078	2 600,40
355/90	TY1100079	3 055,10	TY1700079	2 579,80
355/110	TY1100080	3 055,10	TY1700080	2 579,80
355/125	TY1100081	3 157,60	TY1700081	2 579,80
355/140	TY1100082	3 157,60	TY1700082	2 579,80
355/160	TY1100083	2 983,20	TY1700083	2 468,30
355/180	TY1100084	3 016,70	TY1700084	2 389,90
355/200	TY1100085	2 958,70	TY1700085	2 389,90
355/225	TY1100086	2 645,30	TY1700086	2 257,40
355/250	TY1100087	2 751,90	TY1700087	2 257,40
355/280	TY1100088	2 751,90	TY1700088	2 257,40
355/315	TY1100089	2 136,00	TY1700089	1 773,20
400/63	TY1100090	4 251,90	TY1700090	3 557,90
400/75	TY1100091	4 251,90	TY1700091	3 557,90
400/90	TY1100092	4 248,60	TY1700092	3 531,00
400/110	TY1100093	4 248,60	TY1700093	3 531,00
400/125	TY1100094	4 248,60	TY1700094	3 625,20
400/140	TY1100095	4 248,60	TY1700095	3 625,20
400/160	TY1100096	4 160,20	TY1700096	3 532,80
400/180	TY1100097	4 148,30	TY1700097	3 445,60
400/200	TY1100098	4 095,40	TY1700098	3 445,60
400/225	TY1100099	4 098,30	TY1700099	3 243,20
400/250	TY1100100	3 849,90	TY1700100	3 243,20
400/280	TY1100101	3 849,90	TY1700101	3 243,20
400/315	TY1100102	3 365,70	TY1700102	2 720,60
400/355	TY1100103	3 304,30	TY1700103	2 642,30
450/63	TY1100104	6 113,90	TY1700104	5 223,20
450/75	TY1100105	6 113,90	TY1700105	5 223,20
450/90	TY1100106	6 110,60	TY1700106	5 201,30
450/110	TY1100107	6 110,60	TY1700107	5 201,30
450/125	TY1100108	6 110,60	TY1700108	5 201,30
450/140	TY1100109	6 110,60	TY1700109	5 201,30
450/160	TY1100110	5 997,30	TY1700110	5 084,60
450/180	TY1100111	5 934,10	TY1700111	5 010,80

450/200	TY1100112	5 934,10	TY1700112	5 010,80
450/225	TY1100113	5 667,70	TY1700113	4 692,60
450/250	TY1100114	5 667,70	TY1700114	4 692,60
450/280	TY1100115	5 667,70	TY1700115	4 692,60
450/315	TY1100116	5 221,40	TY1700116	4 162,00
450/355	TY1100117	5 144,90	TY1700117	4 478,80
450/400	TY1100118	5 091,60	TY1700118	4 415,40
500/63	TY1100119	11 465,20	TY1700119	9 278,30
500/75	TY1100120	11 465,20	TY1700120	9 278,30
500/90	TY1100121	11 461,90	TY1700121	9 274,30
500/110	TY1100122	11 461,90	TY1700122	9 274,30
500/125	TY1100123	11 461,90	TY1700123	9 274,30
500/140	TY1100124	11 461,90	TY1700124	9 274,30
500/160	TY1100125	11 348,60	TY1700125	9 139,70
500/180	TY1100126	11 285,40	TY1700126	9 064,40
500/200	TY1100127	11 045,60	TY1700127	9 064,40
500/225	TY1100128	11 045,60	TY1700128	8 779,30
500/250	TY1100129	11 045,60	TY1700129	8 779,30
500/280	TY1100130	11 045,60	TY1700130	8 779,30
500/315	TY1100131	10 572,80	TY1700131	8 217,00
500/355	TY1100132	10 496,20	TY1700132	8 125,90
500/400	TY1100133	10 442,90	TY1700133	8 062,60
500/450	TY1100134	9 027,60	TY1700134	6 379,60
560/63	TY1100135	13 513,10	TY1700135	10 818,70
560/75	TY1100136	13 513,10	TY1700136	10 818,70
560/90	TY1100137	13 509,80	TY1700137	10 814,80
560/110	TY1100138	13 509,80	TY1700138	10 814,80
560/125	TY1100139	13 509,80	TY1700139	10 814,80
560/140	TY1100140	13 509,80	TY1700140	10 814,80
560/160	TY1100141	13 396,60	TY1700141	10 680,10
560/180	TY1100142	13 333,30	TY1700142	10 604,90
560/200	TY1100143	13 333,30	TY1700143	10 604,90
560/225	TY1100144	13 093,60	TY1700144	10 319,80
560/250	TY1100145	13 093,60	TY1700145	10 319,80
560/280	TY1100146	13 093,60	TY1700146	10 319,80
560/315	TY1100147	13 093,60	TY1700147	9 868,30
560/355	TY1100148	12 544,10	TY1700148	9 666,40
560/400	TY1100149	12 490,80	TY1700149	9 603,00
560/450	TY1100150	11 075,60	TY1700150	7 920,00
560/500	TY1100151	11 315,30	TY1700151	8 355,60
630/63	TY1100152	17 189,50	TY1700152	13 214,50
630/75	TY1100153	17 189,50	TY1700153	13 214,50
630/90	TY1100154	17 186,10	TY1700154	13 210,60
630/110	TY1100155	17 186,10	TY1700155	13 210,60
630/125	TY1100156	17 186,10	TY1700156	13 210,60
630/140	TY1100157	17 186,10	TY1700157	13 210,60
630/160	TY1100158	17 071,20	TY1700158	13 075,90
630/180	TY1100159	17 009,60	TY1700159	13 000,70
630/200	TY1100160	16 769,90	TY1700160	13 000,70
630/225	TY1100161	16 769,90	TY1700161	12 715,60
630/250	TY1100162	16 769,90	TY1700162	12 715,60
630/280	TY1100163	16 769,90	TY1700163	12 715,60
630/315	TY1100164	16 297,00	TY1700164	12 153,20
630/355	TY1100165	16 220,40	TY1700165	10 262,20
630/400	TY1100166	16 167,20	TY1700166	11 998,80
630/450	TY1100167	14 751,90	TY1700167	10 315,80
630/500	TY1100168	14 562,10	TY1700168	10 759,30
630/560	TY1100169	14 448,90	TY1700169	10 624,70

Trójnik segmentowy redukcyjny PE100 60st.

d/d1	SDR11		SDR17	
	index	cena	index	cena
90/63	TY1100170	162,60	TY1700170	143,80
90/75	TY1100171	162,60	TY1700171	143,80
110/63	TY1100172	235,60	TY1700172	219,30
110/75	TY1100173	235,60	TY1700173	219,30
110/90	TY1100174	235,60	TY1700174	219,30
125/63	TY1100175	284,90	TY1700175	249,10
125/75	TY1100176	284,90	TY1700176	249,10
125/90	TY1100177	284,90	TY1700177	249,10
125/110	TY1100178	284,90	TY1700178	249,10
140/63	TY1100179	414,90	TY1700179	392,40
140/90	TY1100180	414,90	TY1700180	392,40
140/110	TY1100181	414,90	TY1700181	392,40
140/125	TY1100182	414,90	TY1700182	392,40
160/63	TY1100183	444,80	TY1700183	377,90
160/75	TY1100184	444,80	TY1700184	377,90
160/90	TY1100185	444,80	TY1700185	377,90
160/110	TY1100186	444,80	TY1700186	377,90
160/125	TY1100187	444,80	TY1700187	377,90
160/140	TY1100188	444,80	TY1700188	377,90
180/63	TY1100189	609,20	TY1700189	555,10
180/75	TY1100190	609,20	TY1700190	555,40
180/90	TY1100191	609,20	TY1700191	551,80
180/110	TY1100192	609,20	TY1700192	551,80
180/125	TY1100193	609,20	TY1700193	551,80
180/140	TY1100194	609,20	TY1700194	551,80
180/160	TY1100195	609,20	TY1700195	491,60
200/63	TY1100196	890,30	TY1700196	797,30
200/75	TY1100197	890,30	TY1700197	797,30
200/90	TY1100198	894,40	TY1700198	781,40
200/110	TY1100199	882,80	TY1700199	781,40
200/125	TY1100200	882,80	TY1700200	797,30
200/140	TY1100201	882,80	TY1700201	797,30
200/160	TY1100202	828,00	TY1700202	682,20
200/180	TY1100203	829,00	TY1700203	657,80
225/63	TY1100204	1 118,00	TY1700204	878,50
225/75	TY1100205	1 118,00	TY1700205	878,50
225/90	TY1100206	1 114,70	TY1700206	863,70
225/110	TY1100207	1 114,70	TY1700207	863,70
225/125	TY1100208	1 114,70	TY1700208	863,70
225/140	TY1100209	1 114,70	TY1700209	863,70
225/160	TY1100210	1 053,70	TY1700210	803,90
225/180	TY1100211	1 049,50	TY1700211	770,20
225/200	TY1100212	1 107,40	TY1700212	770,20
250/63	TY1100213	1 297,60	TY1700213	1 070,40
250/75	TY1100214	1 297,60	TY1700214	1 070,40
250/90	TY1100215	1 289,20	TY1700215	1 053,10
250/110	TY1100216	1 289,20	TY1700216	1 053,10
250/125	TY1100217	1 297,60	TY1700217	1 081,00
250/140	TY1100218	1 297,60	TY1700218	1 081,00
250/160	TY1100219	1 179,00	TY1700219	965,00
250/180	TY1100220	1 182,70	TY1700220	1 052,70
250/200	TY1100221	1 168,30	TY1700221	923,20
250/225	TY1100222	1 065,50	TY1700222	923,20

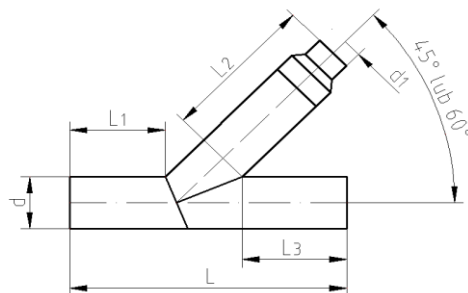

Trójnik segmentowy redukcyjny PE100 45st.

d/d1	SDR11		SDR17	
	index	cena	index	cena
90/63	TY1100223	162,60	TY1700223	143,80
90/75	TY1100224	162,60	TY1700224	143,80
110/63	TY1100225	235,60	TY1700225	219,30
110/75	TY1100226	235,60	TY1700226	219,30
110/90	TY1100227	235,60	TY1700227	219,30
125/63	TY1100228	284,90	TY1700228	249,10
125/75	TY1100229	284,90	TY1700229	249,10
125/90	TY1100230	284,90	TY1700230	249,10
125/110	TY1100231	284,90	TY1700231	249,10
140/63	TY1100232	414,90	TY1700232	392,40
140/90	TY1100233	414,90	TY1700233	392,40
140/110	TY1100234	414,90	TY1700234	392,40
140/125	TY1100235	414,90	TY1700235	392,40
160/63	TY1100236	444,80	TY1700236	377,90
160/75	TY1100237	444,80	TY1700237	377,90
160/90	TY1100238	444,80	TY1700238	377,90
160/110	TY1100239	444,80	TY1700239	377,90
160/125	TY1100240	444,80	TY1700240	377,90
160/140	TY1100241	444,80	TY1700241	377,90
180/63	TY1100242	609,20	TY1700242	555,10
180/75	TY1100243	609,20	TY1700243	555,40
180/90	TY1100244	609,20	TY1700244	551,80
180/110	TY1100245	609,20	TY1700245	551,80
180/125	TY1100246	609,20	TY1700246	551,80
180/140	TY1100247	609,20	TY1700247	551,80
180/160	TY1100248	609,20	TY1700248	491,60
200/63	TY1100249	890,30	TY1700249	797,30
200/75	TY1100250	890,30	TY1700250	797,30
200/90	TY1100251	894,40	TY1700251	781,40
200/110	TY1100252	882,80	TY1700252	781,40
200/125	TY1100253	882,80	TY1700253	797,30
200/140	TY1100254	882,80	TY1700254	797,30
200/160	TY1100255	828,00	TY1700255	682,20
200/180	TY1100256	829,00	TY1700256	657,80

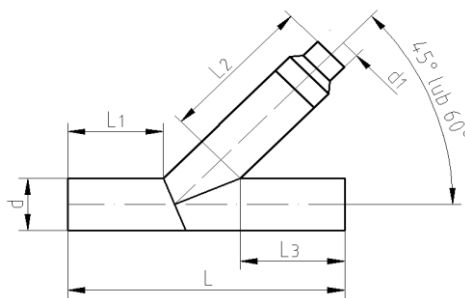

Trójnik segmentowy PE100 kołnierzowy 90st.

d	SDR11		SDR17	
	index	cena	index	cena
90	TK1100090	202,60	TK1700090	190,50
110	TK1100110	257,50	TK1700110	238,70
125	TK1100125	311,50	TK1700125	266,80
140	TK1100140	366,30	TK1700140	327,00
160	TK1100160	453,30	TK1700160	432,90
180	TK1100180	567,70	TK1700180	524,20
200	TK1100200	700,40	TK1700200	634,90
225	TK1100225	844,00	TK1700225	693,00
250	TK1100250	1 188,80	TK1700250	1 027,40
280	TK1100280	1 417,50	TK1700280	1 188,20
315	TK1100315	1 803,20	TK1700315	1 530,70
355	TK1100355	2 689,50	TK1700355	2 304,50
400	TK1100400	3 854,90	TK1700400	3 239,30
450	TK1100450	6 582,40	TK1700450	5 108,40
500	TK1100500	9 372,00	TK1700500	6 660,90
560	TK1100560	13 008,60	TK1700560	8 964,80
630	TK1100630	16 170,00	TK1700630	11 178,90

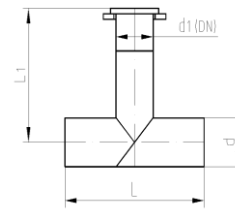

Trójnik segmentowy redukcyjny PE100 kołnierzowy 90st.

d/d1	SDR11		SDR17	
	index	cena	index	cena
90/63	TU1100001	224,60	TU1700001	215,70
90/75	TU1100002	224,60	TU1700002	215,70
110/63	TU1100003	247,60	TU1700003	238,70
110/75	TU1100004	247,60	TU1700004	246,50
110/90	TU1100005	279,70	TU1700005	269,30
125/63	TU1100006	284,60	TU1700006	267,80
125/75	TU1100007	284,60	TU1700007	280,00
125/90	TU1100008	318,80	TU1700008	310,10
125/110	TU1100009	330,00	TU1700009	306,40
140/63	TU1100010	314,20	TU1700010	272,80
140/90	TU1100011	328,30	TU1700011	302,70
140/110	TU1100012	342,00	TU1700012	327,30
140/125	TU1100013	354,50	TU1700013	331,20
160/63	TU1100014	421,30	TU1700014	399,60
160/75	TU1100015	421,30	TU1700015	401,30
160/90	TU1100016	433,40	TU1700016	408,90
160/110	TU1100017	453,00	TU1700017	431,50
160/125	TU1100018	509,60	TU1700018	497,60
160/140	TU1100019	552,60	TU1700019	494,70
180/63	TU1100020	589,80	TU1700020	570,70
180/75	TU1100021	589,80	TU1700021	570,70
180/90	TU1100022	565,40	TU1700022	542,60
180/110	TU1100023	583,70	TU1700023	560,90
180/125	TU1100024	584,60	TU1700024	578,80
180/140	TU1100025	711,00	TU1700025	630,70
180/160	TU1100026	630,60	TU1700026	527,80
200/63	TU1100027	812,40	TU1700027	720,60
200/75	TU1100028	812,40	TU1700028	720,60
200/90	TU1100029	728,10	TU1700029	699,20
200/110	TU1100030	751,20	TU1700030	717,60
200/125	TU1100031	750,00	TU1700031	740,50
200/140	TU1100032	800,00	TU1700032	822,80
200/160	TU1100033	808,60	TU1700033	769,10
200/180	TU1100034	843,20	TU1700034	853,40
225/63	TU1100035	933,20	TU1700035	864,90
225/75	TU1100036	933,20	TU1700036	864,90
225/90	TU1100037	924,10	TU1700037	864,90
225/110	TU1100038	959,50	TU1700038	889,70
225/125	TU1100039	954,60	TU1700039	902,10
225/140	TU1100040	960,80	TU1700040	989,40
225/160	TU1100041	1 264,80	TU1700041	897,80
225/180	TU1100042	1 278,00	TU1700042	1 031,90
225/200	TU1100043	878,00	TU1700043	716,30
250/63	TU1100044	1 109,20	TU1700044	1 054,00
250/75	TU1100045	1 109,20	TU1700045	1 054,00
250/90	TU1100046	1 103,60	TU1700046	1 058,70
250/110	TU1100047	1 116,00	TU1700047	1 064,90
250/125	TU1100048	1 115,00	TU1700048	1 076,40
250/140	TU1100049	1 230,80	TU1700049	1 173,00
250/160	TU1100050	1 138,80	TU1700050	1 047,80
250/180	TU1100051	1 241,00	TU1700051	1 149,20
250/200	TU1100052	1 137,60	TU1700052	1 107,20
250/225	TU1100053	1 296,00	TU1700053	1 133,90
280/63	TU1100054	1 414,90	TU1700054	1 287,40
280/75	TU1100055	1 414,90	TU1700055	1 303,80

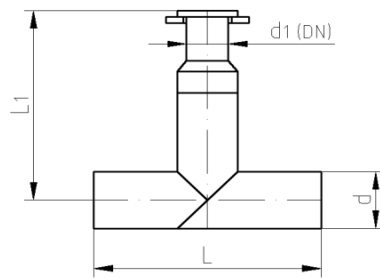

280/90	TU1100056	1 424,30	TU1700056	1 321,60
280/110	TU1100057	1 424,30	TU1700057	1 340,80
280/125	TU1100058	1 424,30	TU1700058	1 391,10
280/140	TU1100059	1 564,00	TU1700059	1 436,50
280/160	TU1100060	1 402,80	TU1700060	1 329,10
280/180	TU1100061	1 538,50	TU1700061	1 448,40
280/200	TU1100062	1 519,00	TU1700062	1 309,00
280/225	TU1100063	1 666,00	TU1700063	1 411,00
280/250	TU1100064	1 503,50	TU1700064	1 161,60
315/63	TU1100065	1 770,10	TU1700065	1 587,20
315/75	TU1100066	1 770,10	TU1700066	1 628,20
315/90	TU1100067	1 796,50	TU1700067	1 598,10
315/110	TU1100068	1 826,80	TU1700068	1 615,10
315/125	TU1100069	1 826,80	TU1700069	1 625,50
315/140	TU1100070	2 002,60	TU1700070	1 783,30
315/160	TU1100071	1 832,10	TU1700071	1 539,20
315/180	TU1100072	2 009,40	TU1700072	1 688,10
315/200	TU1100073	1 828,20	TU1700073	1 615,30
315/225	TU1100074	1 883,60	TU1700074	1 684,70
315/250	TU1100075	1 840,80	TU1700075	1 683,30
315/280	TU1100076	2 006,00	TU1700076	1 846,20
355/63	TU1100077	3 582,90	TU1700077	3 040,60
355/75	TU1100078	3 609,10	TU1700078	3 066,80
355/90	TU1100079	3 620,30	TU1700079	3 078,00
355/110	TU1100080	3 296,50	TU1700080	2 805,30
355/125	TU1100081	3 291,90	TU1700081	2 840,50
355/140	TU1100082	3 680,20	TU1700082	3 137,90
355/160	TU1100083	3 261,70	TU1700083	2 828,00
355/180	TU1100084	3 601,60	TU1700084	3 059,30
355/200	TU1100085	3 124,00	TU1700085	2 623,80
355/225	TU1100086	3 463,20	TU1700086	2 868,60
355/250	TU1100087	3 296,50	TU1700087	2 755,30
355/280	TU1100088	3 680,20	TU1700088	3 070,50
355/315	TU1100089	2 823,30	TU1700089	2 448,40
400/63	TU1100090	4 336,60	TU1700090	3 737,40
400/75	TU1100091	4 360,40	TU1700091	3 761,20
400/90	TU1100092	4 370,50	TU1700092	3 771,50
400/110	TU1100093	4 387,50	TU1700093	3 788,50
400/125	TU1100094	4 404,40	TU1700094	3 830,10
400/140	TU1100095	4 884,40	TU1700095	4 196,30
400/160	TU1100096	4 373,90	TU1700096	3 774,90
400/180	TU1100097	4 805,90	TU1700097	4 117,70
400/200	TU1100098	4 252,70	TU1700098	3 637,00
400/225	TU1100099	4 667,50	TU1700099	3 927,00
400/250	TU1100100	4 387,50	TU1700100	3 744,30
400/280	TU1100101	4 833,40	TU1700101	4 129,00
400/315	TU1100102	4 069,00	TU1700102	3 413,40
400/355	TU1100103	4 624,90	TU1700103	3 911,30
450/63	TU1100104	6 459,00	TU1700104	5 753,40
450/75	TU1100105	6 461,80	TU1700105	5 756,50
450/90	TU1100106	6 477,50	TU1700106	5 773,90
450/110	TU1100107	6 486,90	TU1700107	5 784,40
450/125	TU1100108	6 493,10	TU1700108	5 791,40
450/140	TU1100109	6 512,20	TU1700109	5 826,90
450/160	TU1100110	6 485,60	TU1700110	5 783,00
450/180	TU1100111	6 432,40	TU1700111	5 723,80

450/200	TU1100112	6 435,90	TU1700112	5 676,70
450/225	TU1100113	6 273,20	TU1700113	5 495,50
450/250	TU1100114	6 323,30	TU1700114	5 535,60
450/280	TU1100115	6 342,00	TU1700115	5 556,50
450/315	TU1100116	6 008,30	TU1700116	5 128,90
450/355	TU1100117	6 199,70	TU1700117	5 231,00
450/400	TU1100118	6 389,20	TU1700118	5 405,30
500/63	TU1100119	11 113,50	TU1700119	7 732,90
500/75	TU1100120	11 116,30	TU1700120	9 178,80
500/90	TU1100121	11 131,90	TU1700121	9 196,20
500/110	TU1100122	11 141,30	TU1700122	9 206,70
500/125	TU1100123	11 147,60	TU1700123	9 213,70
500/140	TU1100124	11 166,70	TU1700124	9 249,20
500/160	TU1100125	11 090,00	TU1700125	9 149,50
500/180	TU1100126	11 036,80	TU1700126	9 090,30
500/200	TU1100127	11 115,30	TU1700127	9 126,90
500/225	TU1100128	10 890,10	TU1700128	8 876,00
500/250	TU1100129	11 002,70	TU1700129	8 985,70
500/280	TU1100130	11 021,50	TU1700130	9 006,60
500/315	TU1100131	10 719,00	TU1700131	8 613,90
500/355	TU1100132	10 910,50	TU1700132	8 716,00
500/400	TU1100133	11 068,70	TU1700133	8 855,40
500/450	TU1100134	10 291,10	TU1700134	7 945,80
560/63	TU1100135	15 158,00	TU1700135	10 940,60
560/75	TU1100136	15 160,80	TU1700136	10 943,30
560/90	TU1100137	15 176,40	TU1700137	10 553,70
560/110	TU1100138	15 185,80	TU1700138	10 967,90
560/125	TU1100139	15 192,10	TU1700139	10 974,10
560/140	TU1100140	15 211,20	TU1700140	11 005,40
560/160	TU1100141	15 134,50	TU1700141	10 917,50
560/180	TU1100142	15 087,60	TU1700142	10 871,40
560/200	TU1100143	15 166,10	TU1700143	10 903,70
560/225	TU1100144	14 934,60	TU1700144	10 676,10
560/250	TU1100145	15 047,20	TU1700145	10 773,00
560/280	TU1100146	15 066,00	TU1700146	10 791,40
560/315	TU1100147	14 757,30	TU1700147	10 438,70
560/355	TU1100148	14 923,70	TU1700148	10 504,20
560/400	TU1100149	15 113,20	TU1700149	10 658,00
560/450	TU1100150	13 206,40	TU1700150	8 511,60
560/500	TU1100151	13 372,20	TU1700151	8 763,80
630/63	TU1100152	20 319,20	TU1700152	14 882,70
630/75	TU1100153	20 322,00	TU1700153	14 885,50
630/90	TU1100154	20 337,60	TU1700154	14 900,90
630/110	TU1100155	20 347,00	TU1700155	14 910,10
630/125	TU1100156	20 353,30	TU1700156	14 916,20
630/140	TU1100157	20 372,40	TU1700157	14 947,60
630/160	TU1100158	20 295,70	TU1700158	14 859,60
630/180	TU1100159	20 242,50	TU1700159	14 807,40
630/200	TU1100160	20 321,10	TU1700160	14 839,70
630/225	TU1100161	20 095,80	TU1700161	14 618,30
630/250	TU1100162	20 208,40	TU1700162	14 715,10
630/280	TU1100163	20 214,70	TU1700163	14 721,30
630/315	TU1100164	19 893,50	TU1700164	14 356,30
630/355	TU1100165	20 084,90	TU1700165	14 446,40
630/400	TU1100166	20 274,40	TU1700166	14 660,00
630/450	TU1100167	16 847,40	TU1700167	10 959,30
630/500	TU1100168	16 609,70	TU1700168	10 814,80
630/560	TU1100169	17 457,40	TU1700169	11 279,10

Uskok segmentowy PE100 równoprzelotowy 45st.

d	SDR11		SDR17	
	index	cena	index	cena
90	US1100090	100,30	US1700090	81,00
110	US1100110	110,10	US1700110	104,10
125	US1100125	143,80	US1700125	126,30
140	US1100140	175,00	US1700140	148,70
160	US1100160	200,60	US1700160	177,40
180	US1100180	267,50	US1700180	236,00
200	US1100200	336,60	US1700200	297,70
225	US1100225	403,90	US1700225	349,50
250	US1100250	545,60	US1700250	456,70
280	US1100280	682,00	US1700280	580,60
315	US1100315	886,60	US1700315	700,50

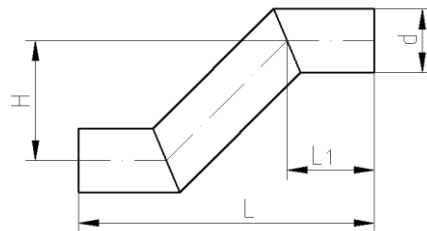

Tuleja kolnierzowa PE100 z króćcem

d	SDR11		SDR17	
	index	cena	index	cena
250	YA110250	206,90	YA170250	194,30
280	YA110280	245,70	YA170280	225,80
315	YA110315	289,80	YA170315	264,60
355	YA110355	443,10	YA170355	438,90
400	YA110400	738,40	YA170400	674,10
450	YA110450	935,00	YA170450	798,60
500	YA110500	1 192,40	YA170500	1 023,00
560	YA110560	1 463,00	YA170560	1 265,00
630	YA110630	1 766,60	YA170630	1 513,60

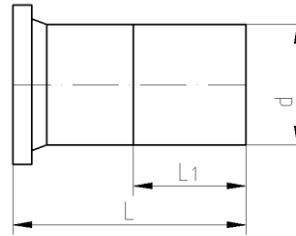

Trójnik siodłowy PE100 redukcyjny 90st.

d/d1	SDR11		SDR17	
	index	cena	index	cena
200/63	ST1100001	687,73	ST1700001	668,40
200/75	ST1100002	687,73	ST1700002	668,40
200/90	ST1100003	910,31	ST1700003	884,10
200/110	ST1100004	910,31	ST1700004	884,10
200/125	ST1100005	910,31	ST1700005	884,10
225/63	ST1100006	765,81	ST1700006	741,10
225/75	ST1100007	765,81	ST1700007	741,10
225/90	ST1100008	983,96	ST1700008	955,80
225/110	ST1100009	983,96	ST1700009	955,80
225/125	ST1100010	983,96	ST1700010	955,80
250/63	ST1100011	918,14	ST1700011	893,00
250/75	ST1100012	918,14	ST1700012	893,00
250/90	ST1100013	1 136,50	ST1700013	1 104,50
250/110	ST1100014	1 136,50	ST1700014	1 104,50
250/125	ST1100015	1 136,50	ST1700015	1 104,50
250/140	ST1100016	1 265,56	ST1700016	1 231,30
250/160	ST1100017	1 265,56	ST1700017	1 231,30
280/63	ST1100018	1 038,03	ST1700018	1 005,90
280/75	ST1100019	1 038,03	ST1700019	1 005,90
280/90	ST1100020	1 259,59	ST1700020	1 223,70
280/110	ST1100021	1 259,59	ST1700021	1 223,70
280/125	ST1100022	1 259,59	ST1700022	1 223,70
280/140	ST1100023	1 387,10	ST1700023	1 352,40
280/160	ST1100024	1 387,10	ST1700024	1 352,40
315/63	ST1100025	1 072,95	ST1700025	1 043,20
315/75	ST1100026	1 072,95	ST1700026	1 043,20
315/90	ST1100027	1 294,61	ST1700027	1 260,30
315/110	ST1100028	1 294,61	ST1700028	1 260,30
315/125	ST1100029	1 294,61	ST1700029	1 260,30
315/140	ST1100030	1 565,60	ST1700030	1 519,40
315/160	ST1100031	1 565,60	ST1700031	1 519,40
315/180	ST1100032	1 719,79	ST1700032	1 668,30
315/200	ST1100033	2 016,33	ST1700033	1 966,20
355/63	ST1100034	1 316,03	ST1700034	1 274,30
355/75	ST1100035	1 316,03	ST1700035	1 274,30
355/90	ST1100036	1 637,80	ST1700036	1 592,90
355/110	ST1100037	1 637,80	ST1700037	1 592,90
355/125	ST1100038	1 535,42	ST1700038	1 490,50
355/140	ST1100039	1 810,43	ST1700039	1 759,60
355/160	ST1100040	1 810,43	ST1700040	1 759,60
355/180	ST1100041	1 959,78	ST1700041	1 912,60
355/200	ST1100042	2 109,03	ST1700042	2 050,30
400/63	ST1100043	1 728,75	ST1700043	1 680,50
400/75	ST1100044	1 728,75	ST1700044	1 680,50
400/90	ST1100045	2 059,79	ST1700045	1 994,70
400/110	ST1100046	2 059,79	ST1700046	1 994,70
400/125	ST1100047	1 967,82	ST1700047	1 899,10
400/140	ST1100048	2 243,24	ST1700048	2 180,70
400/160	ST1100049	2 243,24	ST1700049	2 180,70
400/180	ST1100050	2 377,86	ST1700050	2 321,40
400/200	ST1100051	2 781,62	ST1700051	2 708,20
450/63	ST1100052	2 336,14	ST1700052	2 256,30
450/75	ST1100053	2 336,14	ST1700053	2 256,30
450/90	ST1100054	2 642,98	ST1700054	2 564,00
450/110	ST1100055	2 642,98	ST1700055	2 564,00
450/125	ST1100056	2 548,53	ST1700056	2 478,50
450/140	ST1100057	2 819,11	ST1700057	2 753,10
450/160	ST1100058	2 819,11	ST1700058	2 753,10
450/180	ST1100059	3 067,96	ST1700059	2 984,30
450/200	ST1100060	3 371,91	ST1700060	3 278,60
500/63	ST1100061	3 035,31	ST1700061	2 946,20
500/75	ST1100062	3 035,31	ST1700062	2 946,20

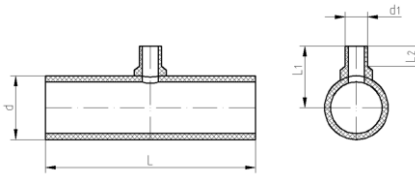

500/90	ST1100063	3 360,48	ST1700063	3 273,60
500/110	ST1100064	3 360,48	ST1700064	3 273,60
500/125	ST1100065	3 252,12	ST1700065	3 172,80
500/140	ST1100066	3 560,40	ST1700066	3 430,60
500/160	ST1100067	3 560,40	ST1700067	3 430,60
500/180	ST1100068	3 805,95	ST1700068	3 669,20
500/200	ST1100069	4 092,40	ST1700069	3 967,50
560/63	ST1100070	4 420,55	ST1700070	4 288,10
560/75	ST1100071	4 420,55	ST1700071	4 288,10
560/90	ST1100072	4 756,95	ST1700072	4 623,10
560/110	ST1100073	4 756,95	ST1700073	4 623,10
560/125	ST1100074	4 660,85	ST1700074	4 522,60
560/140	ST1100075	4 914,03	ST1700075	4 807,00
560/160	ST1100076	4 914,03	ST1700076	4 807,00
560/180	ST1100077	5 178,22	ST1700077	5 035,90
560/200	ST1100078	5 495,26	ST1700078	5 303,00
630/63	ST1100079	5 998,62	ST1700079	5 832,20
630/75	ST1100080	5 998,62	ST1700080	5 832,20
630/90	ST1100081	6 369,73	ST1700081	6 172,80
630/110	ST1100082	6 369,73	ST1700082	6 172,80
630/125	ST1100083	6 246,02	ST1700083	6 087,70
630/140	ST1100084	6 529,89	ST1700084	6 327,60
630/160	ST1100085	6 529,89	ST1700085	6 327,60
630/180	ST1100086	6 796,35	ST1700086	6 563,70
630/200	ST1100087	7 062,92	ST1700087	6 894,20

Trójnik siodłowy PE100 redukcyjny 90st. kołnierzowy

d/d1	SDR11		SDR17	
	index	cena	index	cena
200/63	SK1100001	864,10	SK1700001	862,50
200/75	SK1100002	864,10	SK1700002	862,50
200/90	SK1100003	628,40	SK1700003	575,00
200/110	SK1100004	628,40	SK1700004	575,00
200/125	SK1100005	628,40	SK1700005	575,00
225/63	SK1100006	1 035,30	SK1700006	673,70
225/75	SK1100007	1 035,30	SK1700007	673,70
225/90	SK1100008	705,90	SK1700008	673,70
225/110	SK1100009	705,90	SK1700009	673,70
225/125	SK1100010	705,90	SK1700010	673,70
250/63	SK1100011	1 195,80	SK1700011	752,00
250/75	SK1100012	1 195,80	SK1700012	752,00
250/90	SK1100013	869,70	SK1700013	752,00
250/110	SK1100014	869,70	SK1700014	752,00
250/125	SK1100015	869,70	SK1700015	752,00
250/140	SK1100016	1 217,00	SK1700016	1 158,90
250/160	SK1100017	1 283,00	SK1700017	1 158,90
280/63	SK1100018	1 352,00	SK1700018	829,60
280/75	SK1100019	1 352,00	SK1700019	829,60
280/90	SK1100020	921,80	SK1700020	829,60
280/110	SK1100021	921,80	SK1700021	829,60
280/125	SK1100022	921,80	SK1700022	829,60
280/140	SK1100023	1 350,30	SK1700023	1 236,50
280/160	SK1100024	1 380,30	SK1700024	1 236,50
315/63	SK1100025	1 721,80	SK1700025	1 120,30
315/75	SK1100026	1 893,90	SK1700026	1 120,30
315/90	SK1100027	1 893,90	SK1700027	1 120,30
315/110	SK1100028	1 291,30	SK1700028	1 120,30
315/125	SK1100029	1 291,30	SK1700029	1 120,30
315/140	SK1100030	1 497,00	SK1700030	1 390,30
315/160	SK1100031	1 497,00	SK1700031	1 390,30
315/180	SK1100032	1 497,00	SK1700032	1 390,30
315/200	SK1100033	1 497,00	SK1700033	1 390,30
355/63	SK1100034	1 845,60	SK1700034	1 592,90
355/75	SK1100035	1 845,60	SK1700035	1 592,90
355/90	SK1100036	1 703,70	SK1700036	1 592,90
355/110	SK1100037	1 703,70	SK1700037	1 592,90
355/125	SK1100038	1 703,70	SK1700038	1 592,90
355/140	SK1100039	2 174,50	SK1700039	2 142,10
355/160	SK1100040	2 174,50	SK1700040	2 142,10
355/180	SK1100041	2 174,50	SK1700041	2 142,10
355/200	SK1100042	2 174,50	SK1700042	2 142,10
400/63	SK1100043	2 321,20	SK1700043	1 912,80
400/75	SK1100044	2 142,60	SK1700044	1 912,80
400/90	SK1100045	2 142,60	SK1700045	1 639,50
400/110	SK1100046	2 142,60	SK1700046	1 639,50
400/125	SK1100047	2 142,60	SK1700047	1 639,50
400/140	SK1100048	2 613,50	SK1700048	2 110,30
400/160	SK1100049	2 613,50	SK1700049	2 110,30
400/180	SK1100050	2 613,50	SK1700050	2 110,30

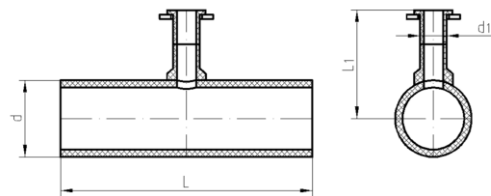

400/200	SK1100051	2 613,50	SK1700051	2 110,30
450/63	SK1100052	2 749,20	SK1700052	2 051,20
450/75	SK1100053	2 749,20	SK1700053	2 051,20
450/90	SK1100054	2 749,20	SK1700054	2 051,20
450/110	SK1100055	2 749,20	SK1700055	2 051,20
450/125	SK1100056	2 749,20	SK1700056	2 051,20
450/140	SK1100057	3 220,10	SK1700057	2 522,00
450/160	SK1100058	3 220,10	SK1700058	2 522,00
450/180	SK1100059	3 220,10	SK1700059	2 522,00
450/200	SK1100060	3 220,10	SK1700060	2 522,00
500/63	SK1100061	4 209,90	SK1700061	3 021,70
500/75	SK1100062	4 209,90	SK1700062	3 021,70
500/90	SK1100063	4 209,90	SK1700063	3 021,70
500/110	SK1100064	4 209,90	SK1700064	3 021,70
500/125	SK1100065	4 209,90	SK1700065	3 021,70
500/140	SK1100066	4 767,90	SK1700066	3 579,70
500/160	SK1100067	4 767,90	SK1700067	3 579,70
500/180	SK1100068	4 767,90	SK1700068	3 579,70
500/200	SK1100069	4 767,90	SK1700069	3 579,70
560/63	SK1100070	5 598,00	SK1700070	4 020,10
560/75	SK1100071	5 598,00	SK1700071	4 020,10
560/90	SK1100072	5 598,00	SK1700072	4 020,10
560/110	SK1100073	5 598,00	SK1700073	4 020,10
560/125	SK1100074	5 598,00	SK1700074	4 020,10
560/140	SK1100075	6 156,00	SK1700075	4 578,10
560/160	SK1100076	6 156,00	SK1700076	4 578,10
560/180	SK1100077	6 156,00	SK1700077	4 578,10
560/200	SK1100078	6 156,00	SK1700078	4 578,10
630/63	SK1100079	7 204,90	SK1700079	5 108,50
630/75	SK1100080	7 204,90	SK1700080	5 108,50
630/90	SK1100081	7 204,90	SK1700081	5 108,50
630/110	SK1100082	7 204,90	SK1700082	5 108,50
630/125	SK1100083	7 204,90	SK1700083	5 108,50
630/140	SK1100084	7 762,90	SK1700084	5 666,50
630/160	SK1100085	7 762,90	SK1700085	5 666,50
630/180	SK1100086	7 762,90	SK1700086	5 666,50
630/200	SK1100087	7 762,90	SK1700087	5 666,50

KSZTAŁTKI WTRYSKOWE DOCZOŁOWE DO WODY I KANALIZACJI CIŚNIENIOWEJ PE100

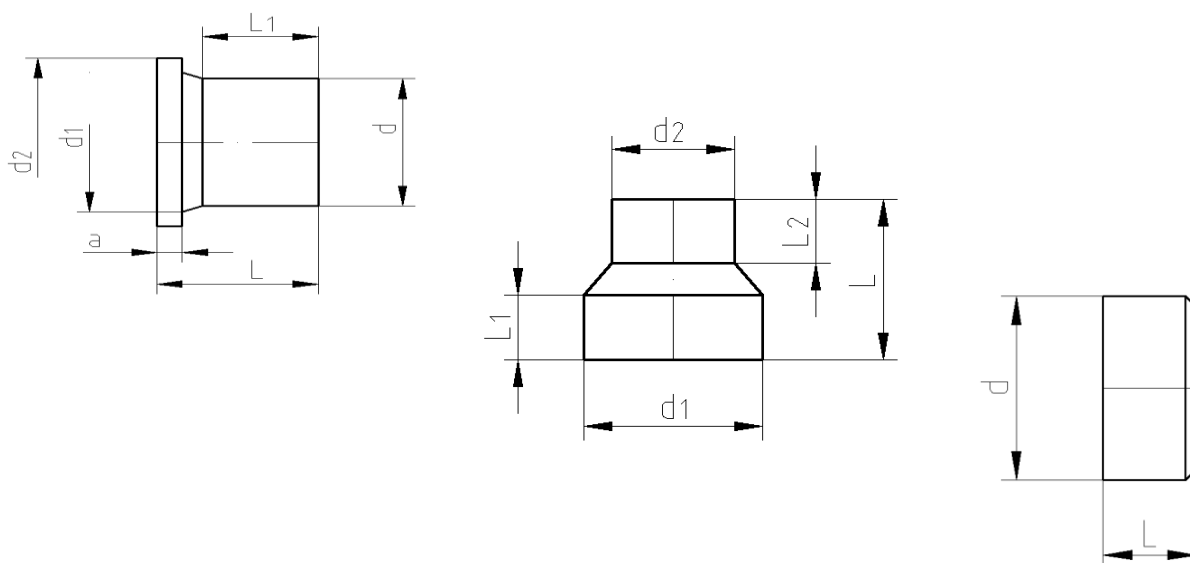

Specyfikacja techniczna

Budowa kształtki:	Tuleje, redukcje, zaślepki – gładkie jednowarstwowe
Przeznaczenie:	kształtki polietylenowe przeznaczone do przesyłania wody i kanalizacji ciśnieniowej
Kolor:	czarny
Normy produktu:	PN-EN 12201-3+A1
Materiał:	PE 100, PE 100 RC
Wymiary:	Ø50 do Ø630; SDR 11, SDR 17
Klasyfikacja statystyczna wyrobu:	PKWiU 25.21-21-53-10
Forma dostawy:	pakowane zbiorczo lub osobno w opakowania kartonowe lub foliowe
Dopuszczenia:	aktualne dokumenty odniesienia znajdują się na stronie www.zinplast.pl

Tuleja kołnierzowa PE100 długa

d	SDR11		SDR17	
	index	cena	index	cena
50	TW1100050	15,00	TW1700050	14,00
63	TW1100063	13,52	TW1700063	12,08
75	TW1100075	18,51	TW1700075	16,65
90	TW1100090	21,85	TW1700090	19,96
110	TW1100110	27,03	TW1700110	25,91
125	TW1100125	34,94	TW1700125	31,50
140	TW1100140	46,00	TW1700140	46,00
160	TW1100160	43,68	TW1700160	41,61
180	TW1100180	79,00	TW1700180	79,00
200	TW1100200	-	TW1700200	87,36
225	TW1100225	-	TW1700225	92,00
355	TW1100355	-	TW1700355	488,00

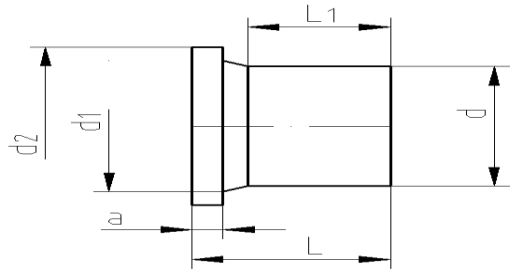

Tuleja kołnierzowa PE100 krótka

d	SDR11		SDR17	
	index	cena	index	cena
200	TW1100200	89,43	TW1700200	81,65
225	TW1100225	99,84	TW1700225	86,10
250	TW1100250	149,76	TW1700250	127,93
280	TW1100280	210,09	TW1700280	178,00
315	TW1100315	257,91	TW1700315	228,81
355	TW1100355	540,00	TW1700355	488,00
400	TW1100400	837,60	TW1700400	777,60
450/450	TW1100451	1 219,68	TW1700451	1 411,00
450	TW1100450	1 219,68	TW1700450	1 200,00
500	TW1100500	1 560,00	TW1700500	1 280,00
560	TW1100560	2 300,00	TW1700560	1 560,00
630	TW1100630	2 700,00	TW1700630	1 800,00

Redukcja centryczna PE100 wtryskowa

d/d1	SDR11		SDR17	
	index	cena	index	cena
90/63	RW1100001	24,00	RW1700001	24,00
90/75	RW1100002	30,00	RW1700002	30,00
110/63	RW1100003	28,00	RW1700003	28,00
110/75	RW1100004	28,00	RW1700004	28,00
110/90	RW1100005	28,00	RW1700005	28,00
125/63	RW1100006	36,00	RW1700006	36,00
125/75	RW1100007	47,30	RW1700007	47,30
125/90	RW1100008	36,00	RW1700008	36,00
125/110	RW1100009	36,00	RW1700009	36,00
140/63	RW1100010	74,25	RW1700010	74,25
140/90	RW1100011	84,00	RW1700011	82,80
140/110	RW1100012	84,00	RW1700012	82,80
140/125	RW1100013	83,00	RW1700013	82,80
160/63	RW1100014	73,70	RW1700014	73,70
160/75	RW1100015	73,70	RW1700015	73,70
160/90	RW1100016	50,00	RW1700016	50,00
160/110	RW1100017	50,00	RW1700017	50,00
160/125	RW1100018	54,00	RW1700018	54,00
160/140	RW1100019	115,00	RW1700019	111,00
180/160	RW1100020	78,00	RW1700020	78,00
200/160	RW1100021	135,00	RW1700021	135,00
225/160	RW1100022	195,00	RW1700022	198,00
200/180	RW1100023	148,00	RW1700023	137,00
225/180	RW1100024	183,00	RW1700024	183,00
225/200	RW1100025	183,00	RW1700025	183,00
250/160	RW1100026	287,00	RW1700026	224,00
250/200	RW1100027	287,00	RW1700027	261,00
250/225	RW1100028	259,00	RW1700028	250,00
280/225	RW1100029	457,00	RW1700029	422,00
280/250	RW1100030	410,50	RW1700030	397,00
315/225	RW1100031	468,93	RW1700031	468,93
315/250	RW1100032	468,93	RW1700032	468,93
315/280	RW1100033	656,90	RW1700033	497,00
355/315	RW1100034	736,89	RW1700034	736,89
400/315	RW1100035	1 534,61	RW1700035	1 534,61
400/355	RW1100036	1 151,40	RW1700036	1 455,74
450/315	RW1100037	1 766,71	RW1700037	1 766,71
450/355	RW1100038	1 664,41	RW1700038	1 664,41
450/400	RW1100039	1 593,57	RW1700039	1 593,57
500/450	RW1100040		RW1700040	2 159,00
560/450	RW1100041		RW1700041	2 159,00
560/500	RW1100042		RW1700042	2 159,00
630/450	RW1100043		RW1700043	3 885,00
630/500	RW1100044		RW1700044	2 159,00
630/560	RW1100045		RW1700045	2 159,00

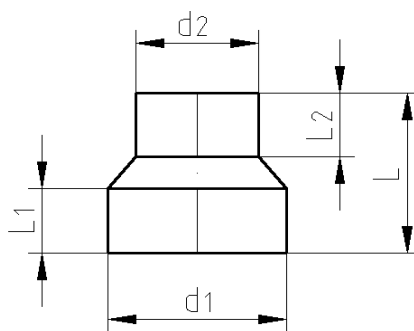

Zaślepka PE100 wtryskowa

d	SDR11		SDR17	
	index	cena	index	cena
90	ZW1100090	21,58	ZW1700090	25,21
110	ZW1100110	32,84	ZW1700110	28,66
125	ZW1100125	40,02	ZW1700125	42,00
140	ZW1100140	62,00	ZW1700140	62,00
160	ZW1100160	68,00	ZW1700160	64,94
180	ZW1100180	99,76	ZW1700180	100,00
200	ZW1100200	110,00	ZW1700200	110,00
225	ZW1100225	130,00	ZW1700225	130,00
250	ZW1100250	234,32	ZW1700250	195,34
280	ZW1100280	286,54	ZW1700280	221,18
315	ZW1100315	409,12	ZW1700315	351,58

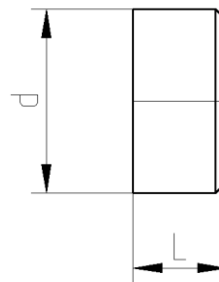

Kołnierze stalowe galwanizowane

DN/d	PN16		PN10	
	index	cena	index	cena
40/50	GE1600001	47,15	GE1000001	47,15
50/63	GE1600002	37,95	GE1000002	37,95
65/75	GE1600003	47,61	GE1000003	47,61
80/90	GE1600004	55,66	GE1000004	55,66
100/110	GE1600005	63,71	GE1000005	63,71
100/125	GE1600006	62,10	GE1000006	62,10
125/125	GE1600007	95,45	GE1000007	95,45
125/140	GE1600008	83,26	GE1000008	83,26
150/160	GE1600009	98,67	GE1000009	98,67
150/180	GE1600010	92,92	GE1000010	92,92
200/200	GE1600011	131,10	GE1000011	147,20
200/225	GE1600012	137,08	GE1000012	137,89
250/250	GE1600013	273,70	GE1000013	210,91
250/280	GE1600014	220,11	GE1000014	199,64
300/315	GE1600015	351,67	GE1000015	264,50
350/355	GE1600016	550,62	GE1000016	386,40
400/400	GE1600017	662,40	GE1000017	515,20
450/450	GE1600018	825,70	GE1000018	630,20
500/450	GE1600019	1 207,50	GE1000019	833,75
500/500	GE1600020	1 101,24	GE1000020	762,45
600/560	GE1600021	1 863,00	GE1000021	1 122,40
600/630	GE1600022	1 794,00	GE1000022	936,10

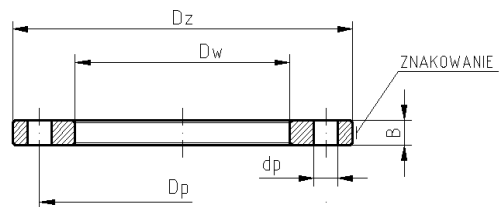

Uszczelka gumowa płaska

DN	index	cena
40	UG0000040	2,04
50	UG0000050	2,04
65	UG0000065	2,40
80	UG0000080	2,88
100	UG0000100	3,12
125	UG0000125	4,20
150	UG0000150	5,04
200	UG0000200	8,40
250	UG0000250	10,08
300	UG0000300	13,20
350	UG0000350	16,80
400	UG0000400	28,80
500	UG0000500	40,80
600	UG0000600	na zapytanie

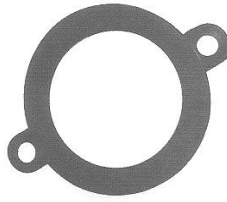

Mufa elektrooporowa PE100

D	SDR17		SDR11	
	index	cena	index	cena
20			ME1100020	9,60
25			ME1100025	11,28
32			ME1100032	12,24
40			ME1100040	14,16
50			ME1100050	18,24
63			ME1100063	21,36
75			ME1100075	32,40
90			ME1100090	37,44
110	ME1700110	43,20	ME1100110	46,56
125	ME1700125	64,80	ME1100125	69,60
140	ME1700140	76,80	ME1100140	84,00
160	ME1700160	84,00	ME1100160	93,60
180	ME1700180	112,80	ME1100180	117,60
200	ME1700200	141,60	ME1100200	148,80
225	ME1700225	184,80	ME1100225	196,80
250	ME1700250	252,00	ME1100250	266,40
280	ME1700280	343,20	ME1100280	381,60
315	ME1700315	360,00	ME1100315	400,80
400	ME1700400	806,40	ME1100400	1 068,00

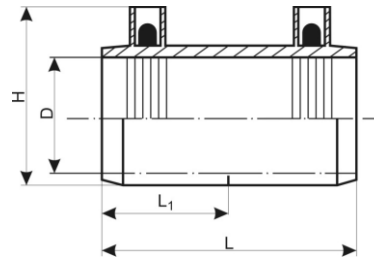

Zaślepka elektrooporowa PE100 SDR11

D	index	cena
20	ZE0000020	17,28
25	ZE0000025	17,76
32	ZE0000032	19,20
40	ZE0000040	20,16
50	ZE0000050	26,40
63	ZE0000063	30,24
75	ZE0000075	43,44
90	ZE0000090	49,44
110	ZE0000110	66,72
125	ZE0000125	126,00
140	ZE0000140	187,20
160	ZE0000160	196,80
180	ZE0000180	391,20
200	ZE0000200	468,00
225	ZE0000225	578,40
250	ZE0000250	739,20
280	ZE0000280	1 056,00
315	ZE0000315	1 274,40

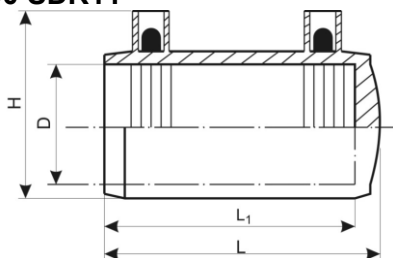

Łuk elektrooporowy PE100 SDR11 45st.

D	index	cena
25	KE4500025	29,28
32	KE4500032	30,24
40	KE4500040	40,32
50	KE4500050	47,52
63	KE4500063	54,48
75	KE4500075	86,40
90	KE4500090	88,80
110	KE4500110	127,20
125	KE4500125	184,80
140	KE4500140	235,20
160	KE4500160	278,40
180	KE4500180	528,00
200	KE4500200	684,00
225	KE4500225	1 010,40
250	KE4500250	1 896,00

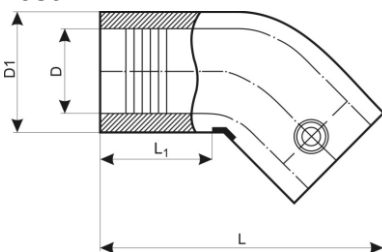

Łuk elektrooporowy PE100 SDR11 90st.

D	index	cena
32	KE9000032	30,24
40	KE9000040	40,32
50	KE9000050	48,00
63	KE9000063	55,20
75	KE9000075	84,67
90	KE9000090	88,80
110	KE9000110	127,20
125	KE9000125	184,80
140	KE9000140	na zapytanie
160	KE9000160	277,20
180	KE9000180	961,20
200	KE9000200	904,80
225	KE9000225	1 044,00
250	KE9000250	1 992,00

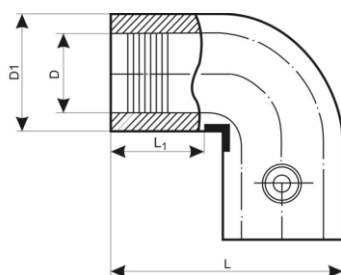

Redukcja elektrooporowa PE100 SDR11

D1/D2	index	cena
25/20	RE0000001	14,40
32/20	RE0000002	15,12
32/25	RE0000003	16,32
40/25	RE0000004	19,20
40/32	RE0000005	22,80
50/25	RE0000006	24,24
50/32	RE0000007	26,40
50/40	RE0000008	27,60
63/25	RE0000009	33,60
63/32	RE0000010	33,60
63/40	RE0000011	33,60
63/50	RE0000012	33,60
75/50	RE0000013	64,80
75/63	RE0000014	64,80
90/63	RE0000015	64,80
90/75	RE0000016	93,60
110/63	RE0000017	94,80
110/90	RE0000018	94,80
125/90	RE0000019	100,80
125/110	RE0000020	100,80
140/125	RE0000021	100,80
160/90	RE0000022	252,00
160/110	RE0000023	127,20
160/125	RE0000024	139,20
160/140	RE0000025	206,40
180/125	RE0000026	288,00
200/160	RE0000027	552,00
225/160	RE0000028	600,00

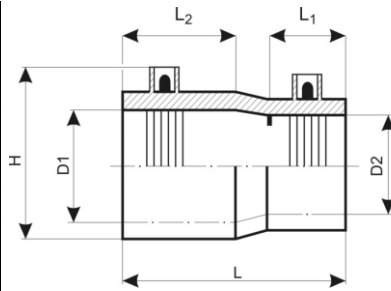

Redukcja elektrooporowa PE100 SDR11

D1/D2	index	cena
25/25	TE0000001	69,60
32/32	TE0000002	69,60
40/40	TE0000003	91,20
50/50	TE0000004	112,80
63/63	TE0000005	122,40
75/75	TE0000006	177,60
90/90	TE0000007	216,00
110/110	TE0000008	338,40
125/125	TE0000009	427,20
140/140	TE0000010	540,00
160/160	TE0000011	792,00
180/180	TE0000012	1 603,20
200/200	TE0000013	2 671,20
225/225	TE0000014	2 671,20
250/250	TE0000015	5 880,00

